



**Invitation to Bid, No. 20-101
CAPITAL PAVING RESURFACING**

December 18, 2019

A Mandatory Pre-Bid Conference will be held on **Tuesday, January 7, 2020, at 2:30 p.m. at Brookhaven City Hall, 4362 Peachtree Rd. Brookhaven, GA 30319.**

Questions regarding the ITB process should be directed in writing to the Purchasing Manager via email at purchasing@brookhavenga.gov. Only questions received prior to **4:00 p.m. on Monday, January 13, 2020**, will be considered.

BID DUE DATE and PUBLIC OPENING: Tuesday, January 21, 2020, at 2:30 p.m. EST. Submit bids to Brookhaven City Hall, 4362 Peachtree Road NE., Brookhaven, GA 30319 Any bid received after this date and time will not be accepted.

Instructions to Bidders:

All spaces below are to be completed and the ITB Letter page must be signed where indicated.
Failure to sign and return the ITB Letter may cause rejection of the Bid.

Bidder Information:

Company Name: _____

Address: _____

Telephone: _____

Email: _____

Contact Name: _____

Signature: _____

The Delivery shall include two (2) sealed bids (one (1) original, one (1) copies) and one (1) USB flash drive, along with one (1) copy of the bid schedule in a sealed envelope to the Purchasing Department, City of Brookhaven, 4362 Peachtree Road NE., Brookhaven, Georgia 30319. Delivery of bids shall be submitted via hand delivery or commercial carrier (i.e. U.S. Postal Service, UPS, FedEx, etc.) only. **FAILURE TO RETURN THE CONTRACT DOCUMENTS MAY RESULT IN THE BID BEING DEEMED NON-RESPONSIVE AND AUTOMATIC REJECTION**

CONTRACT FOR ITB 20-101
CAPITAL PAVING RESURFACING

This **CONTRACT** made and entered into this ____ day of _____, 2019 by and between the City of Brookhaven, (Party of the First Part, hereinafter called the “City”), and - _____ Party of the Second Part, hereinafter called the “Service Provider” or “Contractor”).

NOW THEREFORE, for and in consideration of the mutual promises and obligations contained herein and under the conditions hereinafter set forth, the parties do hereby agree as follows:

1. TERMS:

The services to be performed under this Contract shall commence upon the date stated in the Notice to Proceed Letter. The contract period for this contract is 90 days from the date stated in the Notice to Proceed Letter. Upon the completion of the full scope of work the contract shall terminate absolutely and without further obligation as required by O.C.G.A. §36-60-13, as amended, unless terminated earlier in accordance with the provisions of this Contract.

2. ATTACHMENTS:

The following documents are attached and are specifically incorporated herein by reference; and, along with this Contract and the General Conditions attached as Exhibit A encompass all of the **Contract documents**:

- Exhibit A: General Conditions.
- Exhibit B: Specifications and Scope of Work (ITB 20-101 reference herein).
- Exhibit C: Determination of Responsibility.
- Exhibit D: Bond Documents: Payment Bond, Performance Bond and Maintenance Bond.
- Exhibit E: Georgia Security and Immigration Compliance Affidavit.
- Exhibit F: Drug-Free Workplace.
- Exhibit G: Purchasing Policy Addendum.
- Exhibit H: Affidavit Verifying Status for Public Benefit Application.
- Exhibit I: Bid Documents: References and Subcontractor Form.
- Exhibit J: Non-Collusion Affidavit
- Exhibit K: Bid Schedule.
- Exhibit L: Diagrams and Public Works Department Special Provisions
Modifications of the GDOT Standard Specifications, 2013 Edition.

3. PERFORMANCE:

Service Provider agrees to furnish all skill and labor of every description necessary to carry out perform, perform the services in accordance with the Contract Documents (the “Work”).

4. PRICE:

The City agrees to pay the Service Provider following receipt by the City of a detailed invoice reflecting the actual work performed by the Service Provider, provided, however, Service Provider guarantees that the maximum price for materials, labor, and expenses, shall be the amount reflected in Exhibit J.

5. INDEMNIFICATION AND HOLD HARMLESS:

[See Section 13 of Exhibit A. --- General Conditions]

Service Provider further agrees to protect, defend, indemnify, and hold harmless the CITY, its council members, officers, agents, and employees from and against any and all claims or liability for compensation under the Worker's Compensation Act arising out of injuries sustained by any employee or subcontract of the Service Provider, as allowed under the law.

6. TERMINATION FOR CAUSE:

The City may terminate this Contract for cause upon ten (10) days prior written notice to the Service Provider of the Service Provider's default in the performance of any term of this Contract. Such termination shall be without prejudice to any City's rights or remedies provide by law.

7. TERMINATION FOR CONVENIENCE:

The City may terminate this Contract for its convenience at any time upon 30 days written notice to the Service Provider. In the event of the City's termination of this Contract for convenience, the Service Provider will be paid for those services actually performed. Partially completed performance of the Contract will be compensated based upon a signed statement of completion to be submitted by the Service Provider who shall itemize each element of performance.

8. TERMINATION FOR FUND APPROPRIATION:

The City may unilaterally terminate this Contract due to lack of funding at any time by written notice to the Service Provider. In the event of the City's termination of this Contract for fund appropriation, the Service Provider will be paid for those services actually performed. Partially completed performance of the Contract will be compensated based upon a signed statement of completion to be submitted by the Service Provider which shall itemize each element of performance.

9. CONTRACT NOT TO DISCRIMINATE:

During the performance of this Contract, the Service Provider will not discriminate against any employee or applicant for employment because of race, creed, color, color, sex, national origin, age, or disability which does not preclude the applicate or employee from performing the essential functions of the position. The Service Provider will also, in all solicitations or advertisements for employees placed by qualified applicants, consider the same without regard to race, creed, color, sex, national origin, age, or disability which does not preclude the applicant from performing the essential functions of the job. The Service Provider will cause the foregoing provisions to be inserted in all subcontracts for any work covered by this Contract so that such provision will be binding upon each sub-service providers for standard commercial supplies of raw materials.

10. CONTRACT NOT TO DISCRIMINATE:

During the performance of this Contract, the Service Provider will not discriminate against any employee or applicant for employment because of race, creed, color, color, sex, national origin, age, or disability which does not preclude the applicate or employee from performing the essential functions of the position. The Service Provider will also, in all solicitations or advertisements for employees placed by qualified applicants, consider the same without regard to race, creed, color, sex, national origin, age, or disability which does not preclude the applicant from performing the essential functions of the job. The Service Provider will cause the foregoing provisions to be inserted in all subcontracts for any work covered by this Contract so that such provision will be binding upon each sub-service providers for standard commercial supplies of raw materials.

11. ASSIGNMENT:

The Service Provider shall not sublet, assign, transfer, pledge, convey, sell or otherwise dispose of the whole or any part of this Contract or his right, title, or interest therein to any person, firm, or corporation without the previous consent of the City in writing.

12. WAIVER:

A waiver by either party of any breach of any provision, term, covenant, or condition of this Contract shall not be deemed a waiver of any subsequent breach of the same or any other provision, term, covenant, or condition.

13. SEVERABILITY:

The parties agree that each of the provisions included in this Contract is separate, distinct and severable from the other and remaining provisions of this Contract and that the invalidity of any Contract provision shall not affect the validity of any other provision or provisions of this Contract.

14. GOVERNING LAW:

The parties agree that this Contract shall be governed and construed in accordance with the laws of the State of Georgia. This Contract has been signed in DeKalb County, Georgia.

15. MERGER CLAUSE:

The parties agree that the terms of this Contract included the entire Contract between the parties, and as such, shall exclusively bind the parties. No other representations, either oral or written, may be used to contradict the terms of this Contract.

IN WITNESS WHEREOF, the parties hereto, acting through their duly authorized agents, have caused this **CONTRACT** to be signed, sealed and delivered.

Signatures on the following page.

Brookhaven, GEORGIA

By: _____
John Arthur Ernst, Jr.
Mayor City of Brookhaven, Georgia

ATTEST: _____
Susan Hiott
City Clerk

APPROVED AS TO FROM:

Chris Balch., City Attorney

SERVICE PROVIDER:

Signature _____

Date _____

Print Name _____

Print Title _____

ATTEST:

Date _____

Signature

Print Name _____

Print Title _____

EXHIBIT A

GENERAL CONDITIONS

1. SCOPE OF WORK

The Contract will be to provide services to the City in accordance with the Contract Documents. All work shall be performed in accordance with the Scope of Services attached hereto as Exhibit B.

2. REGULATIONS

- 2.1 The Service Provides shall comply with all applicable federal, state and local laws, ordinances, rules and regulations pertaining to the performance of the work specified herein.
- 2.2 The Service Provider shall obtain all permits, licenses, and certificates, or any such approvals of plans or specifications as may be required by Federal, State, and local laws, ordinance, rules and regulations, for the proper execution of the work specified herein.
- 2.3 During the performance of this Contract, the Service Provider shall keep current and, if requested by the City, provide copies of any and all licenses, registrations or permits required by applicable governing agencies, The Service Provider shall keep a copy of any and all licenses, registrations and permits on the job site while performing the Contract work.
- 2.4 The Service Provider will comply with the City of Brookhaven's Financial Management and Purchasing Policies.
- 2.5 Service Provider will complete all work in accordance with all applicable legal requirements, including but not limited to O.C.G.A. § 50-5-63, as applicable.

3. WORK HOURS

- 3.1 The Contractor shall normally perform on-site work during Standard Work Hours which are between 7:00 a.m. and 7:00 p.m., Monday through Friday, excluding City's observed holidays. The City may require the Contractor to perform work on the city's premises during Non-standard Work Hours which are outside the Standard Work Hours. Non-Standard Work Hours may be arranged with prior written approval of the City. The Contractor shall advise the City no less than 72 hours in advance of its projected work schedule. The Contractor shall perform no work during City observed holidays without the prior written permission of the City.
- 3.2 In the event an emergency condition is declared by the City's Manager of his respective designee, the Contractor will perform work during such hours as requested by the City.
- 3.3 The City may order the Service Provider to suspend, delay, or interrupt all or any part of the work on for such a period of time as he may determine appropriate for the convenience of the City. The time for completion of the work shall be extended by the number of days they work is suspended. The City shall not be responsible for any claims, damages or costs stemming from any delay of the work.

4. SERVICE PROVIDER'S PERSONNEL

- 4.1 The Service Provider will abide by all State and Federal regulations on wages and hours of an employee dealing with the employment relationship between the Service Provider and its subsidiaries or related parties and its employees, including but not limited to the

EXHIBIT A

GENERAL CONDITIONS

- Federal National Labor Relations Act, the Federal Fair Labor Standards Act, the Federal Civil Rights Act of 1964, as amended, and the Americans with Disabilities Act.
- 4.2 The Service Provider shall require all prospective employees to show proof of citizenship, or proof from the United States Immigration and Naturalization Service of valid entry permits and/or work permits for legal aliens and proof that such legal aliens are eligible to be employed in the United States. This includes any requirement for participation in the DHS e-Verify or SAVE program.
- 4.3 Should the Service Provider engage employees who are illiterate in English, it will be the Service Provider's responsibility and obligation to train such employees to be able to identify and understand all signs and notices in and /or around the areas that relate to them or the services being performed by them pursuant to this Contract. In addition, the Service Provider will have someone in attendance at all times who can communicate instructions to said employee.
- 4.4 The Service Provider shall maintain a drug-free workplace within the meaning of the Georgia Drug-free Workplace Act. No employee shall be hired by a Service Provider for work on the City's premises prior to such employee having tested negative for drugs. In addition, existing employees have tested negative for drugs. In addition, existing employees of the Service Provider must be subject to drug testing by the Service Provider upon reasonable suspicion of drug use. Results of all such drug tests are to be retained by the Service Provider. Copies shall be provided to the City if requested.
- 4.5 The Service Provider shall transfer promptly from the City any employee or employees that the City advises are not satisfactory and replace such personnel with employees satisfactory to the City; but in no event shall the City be responsible for monitoring or assessing the suitability of any employee or agent of the Service Provider.
- 4.6 The Service Provider's employees shall be instructed that no gratuities shall be solicited or accepted for any reason whatsoever from the tenants, customers or other persons at the City.
- 4.7 A valid driver license (Commercial Driver License, if applicable) will be required of all personnel operating motor vehicles or motorized equipment on roadways in or around the City.
- 4.8 While working on city property all Service Provider's employees shall wear neat-appearing business casual attire or uniforms with the company name and/ or logo and footwear of a style that complies with all legal and safety requirements, including and without limitation, the requirements of OSHA.
- 4.9 Designation of Supervisor-the Service Provider shall designate an experienced Supervisor ("Supervisor") acceptable to the City for all purposes related to the work. The initial Supervisor shall be (TBD).
- 4.9.1 The Supervisor shall be fully responsible for the Service Provider meeting all of its obligations under this Contract. The Supervisor shall provide the City with an appropriate status report on the progress of the project.
- 4.9.2 The Supervisor shall be available, as reasonably required, to be on-site during necessary times. Such times shall be discussed between the Supervisor and the City, but the final required times will be the City's discretion.

EXHIBIT A

GENERAL CONDITIONS

4.9.3 In the event that the designated Supervisor terminates employment with the Service Provider or is requested by the City to be removed from the role of Supervisor (as provided in Section 4.5), the position shall be assumed by an individual with equivalent qualifications, experience, and knowledge. Such replacement shall require the City's prior approval.

4.10 The process by which the implementation partner requests the removal of a team member from the project. If a Service Provider replaces a proposed team member, the Service Provider shall replace that team member of similar experience. The City reserves the right to accept or reject any proposed or replacement team member, with or without cause, at any time during the duration of the project.

5. TOOLS AND EQUIPMENT

It shall be the sole responsibility of the Service Provider to provide for all tools, parts, and equipment necessary to perform work under this Contract.

6. PERFORMANCE REQUIREMENTS

6.1 The Service Provider shall perform all of its obligations and functions under the Contract in accordance with the Contract specifications and industry standards. The Service Provider shall adjust and coordinate its activities to the needs and requirements of the City and perform its activities so as not to annoy, disturb, endanger, unreasonably interfere with or delay the operations or activities of the City.

6.2 The Service Provider's personnel shall perform work in compliance with all Federal, State, and City of Brookhaven regulations.

6.3 Dates for commencement and completion of work shall be coordinated with the City's Authorized Representative (CAR).

6.4 Any work required beyond that which is specified herein shall be reported in advance to the City. At no time shall work beyond the scope be performed without prior written authorization from the City.

6.5 The Service Provider shall utilize maximum safety procedures. Tools and equipment will be in a good state of repair, safe to use, and be used in the manner in which they were intended. The Service Provider is required to inform all workers and concerned persons of the Material Safety Data on all products being utilized on this project. No materials or equipment will be left unattended at any time.

7. CONFIDENTIAL INFORMATION

7.1 In the course of performing the contract work, the Service Provider may gain access to security-sensitive and other sensitive information of the City.

7.2 The Service Provider agrees to hold all City data and information in confidence and to make such information known only to its employees and subcontracts who

EXHIBIT A

GENERAL CONDITIONS

have a legitimate need to know such information and only after advising such persons of the Service Provider's non-disclosure obligations.

7.3 The Service Provider shall seek the City's prior written consent before using for any purpose other than the fulfillment of the Service Provider's obligations hereunder, or before releasing, disclosing, or otherwise making such information available to any other person.

7.4 The Service Provider shall employ such practices and take such actions to protect the City's information from unauthorized use or disclosure as the Service Provider employs and takes to protect its own information, but in no event shall the Service Provider use less than reasonable efforts to protect the City's information.

7.5 The provisions of this Section shall survive the expiration or earlier termination of the Contract.

8. USE OF PREMISES

During the progress of the work specified herein, to the extent any work is performed on the City's premises, the Service Provider shall keep the premises free from accumulation of waste materials, and other debris resulting from, work and about the premises as well as tools, equipment, machinery and surplus material, and leave the site clean and ready for occupancy by the City.

9. SAFETY AND PROTECTION

The Service Provider shall be solely and completely responsible for initiating, maintaining and supervising all safety precautions for the safety of, and shall provide the necessary protection to prevent damage, injury or loss to all employees on the worksite and other persons including, but not limited to, the general public who may be affected thereby.

10. COMPENSATION – INVOICE AND PAYMENT FOR SERVICES

10.1 The City shall pay the Service Provider, subject to any authorized deductions, the applicable prices set forth for each service authorized by the City, and actually delivered or performed, as the case may be, by the Service Provider to the satisfaction and acceptance, as appropriate, of the City. The timing of such payments shall be as set forth below in the Section.

10.2 The Service Provider shall invoice with such supporting documentation and other backup material as the City may reasonably require. The Service Provider shall provide the Proof of Payment attached as an Exhibit hereto, indicating all subcontractors have paid, with each invoice.

10.3 The Service Provider shall deliver to the City approval and acceptance, and before eligible for final payment of any amounts due, all documents and material prepared by the Service Provider for the City under this Contract.

EXHIBIT A

GENERAL CONDITIONS

- 10.4 The City shall pay the undisputed amount of the Service Provider's invoice, as it may be reduced to reflect unsubstantiated or unsatisfactory service. Items in dispute shall be paid upon the resolution of the dispute. No verification or payment of any amounts invoiced shall preclude the City from recovering any money paid in excess of that due under the terms of this Contract.
- 10.5 The Service Provider shall be obligated to pay promptly all proper charges and costs incurred by the Service Provider for labor and expenses incurred for the work performed hereunder. The City shall have the right, but not the obligation, to pay directly to third parties (including subcontractors) all past due amounts owed by the Service Provider to third parties for labor and materials used for the work hereunder, based on invoices submitted by such third party, and all such amounts paid by the City shall be applied toward, and shall reduce, amount owed to Service Provider hereunder.
- 10.6 The Service Provider shall submit all invoices City of Brookhaven Public Works Department electronically to pwadmin@Brookhavenga.gov and copy to
City of Brookhaven, GA, Accounts Payable, 4362 Peachtree Road NE,
Brookhaven, GA 30319.
- 10.7 The Service Provider will agree to comply with the City of Brookhaven's Financial Policies and Purchasing Policy, to the extent applicable.
- 10.8 The Service Provider agrees that the compensation provided herein shall be full and final settlement of all claims arising against Brookhaven for work done, materials furnished, costs incurred or otherwise arising out of this contract and shall release the City from any and all further claims related to the payment for services and materials furnished in connection with this Agreement.
- 10.9 The Service Provider and City agree that in any event a provision of this Contract pertaining to the time of payment, the rate of payment, and any rates of interest differs from any provision of the Prompt Pay Act, such provision of the Prompt Pay Act are hereby waived and said Contract provision shall control. The City shall not be responsible for any interest penalty or for any late payment.

11. COMPLIANCE WITH LAWS AND REGULATIONS

- 11.1 The Service Provider shall perform its obligations and functions hereunder in compliance with the applicable laws of the United States, the State of Georgia, DeKalb County, the City of Brookhaven, any applicable rules, regulations or directives of any agency thereof, and the applicable regulations of the City. OSHA rules and regulations shall be followed at all times. The City shall have the right (but not the obligation) to contest or challenge by any means whatsoever any law, regulation, rule or directive which in any way affects or otherwise impacts upon the Service Provider's performance of its obligations and functions hereunder; the Service Provider shall cooperate to the fullest extent and take whatever action (including becoming a party in any litigation) the City should reasonable request in connection with any such challenge or contest by the City.

GENERAL CONDITIONS

- 11.2 The Service Provider shall obtain and keep current all licenses, permits and authorizations, whether municipal, county, state or deferral, required for the performance of its obligations and functions hereunder and shall pay promptly when due all fees, therefore.
- 11.3 The Service Provider shall abide by all applicable state and federal regulations pertaining to wages and hours of employees; including but not limited to the Service Provider's compliance with requirements of O.C.G.A. 13-10-91 AND Rule 300-104-1-.02.

12. SERVICE PROVIDER'S LIABILITY

The Service Provider shall be responsible for the prompt payment of any fines imposed on the city or the Service Provider by any other federal, state or local governmental agency as a result of the Service Provider's, or its subcontractor's (or the officers' directors', employees' or agents' of either), failure to comply with the requirements of any law or any governmental agency rule, regulation, order or permit. The liability of the Service Provider under this Section 12 is in addition to and in no way a limitation upon any other liabilities and responsibilities which may be imposed by applicable law or by the indemnification provision of Section 13 hereof, and such liability shall survive the expiration or earlier termination of this Contract.

13. INDEMNIFICATION AND INSURANCE

- 13.1 The Service Provider shall, to the extent allowed under Georgia law, indemnify, defend and hold completely harmless the City, and the members (including, without limitation, members of the City's Council, and members of the boards and of the City), officers, employees and agents of each, from and against any and all liabilities (including statutory liability and liability under Workers' Compensation Laws), losses, suits, claims, demands, judgments, fines, damages, costs and expenses (including all costs for investigation and defense thereof, including, but not limited to, court costs, paralegal and expert fees and reasonable attorneys' fees) which may be incurred by, charged to or recovered from any of the foregoing by (i) reason or on account of damage to or destruction or loss of any property of the City, or any property of, injury to or death of any person resulting from or arising out of or in connection with the performance of this Contract, or the acts or omissions of the Service Provider's directors, officers, agents, employees, subcontractors, licensees or invitees, in connection with the performance of this contract regardless of where the damage, destruction, injury or death occurred, **unless** such liability, loss, suit, claim, demand, judgment, fine, damage, cost or expense was proximately caused solely by the City's negligence or by the joint negligence of the City and any person other than the Service Provider or the Service Provider's directors, officers, agents, employees, subcontractors, licensees, or invitees, or (ii) arising out of or in connection with the failure of the Service Provider to keep, observe or perform any of the covenants or agreements in this Contract which required to be kept, observed or performed by the Service Provider, or (iii) arising out of or in connection with any claim, suit, assessment or judgment prohibited by Section 13.4 below by or in

EXHIBIT A

GENERAL CONDITIONS

favor of any person described in Section 13.5 below, or (iv) arising out of or in connection with any action by Service Provider or its directors, officers, agents, employees, subcontractors, licensees or invitees. The City agrees to give the Service Provider reasonable notice of any suit or claim for which indemnification will be sought hereunder, to

allow the Service Provider or its insurer to compromise and defend the same to the extent of its interest, and to reasonably cooperate with the defense of any such suit or claim. In carrying out its obligations under this section, the Service Provider shall engage counsel reasonably acceptable to the City. In any suit, action, proceeding, claim or demand brought in respect of which the City may pursue indemnity, the City shall have the right to retain its own counsel, but the fees and expenses of such counsel shall be at the expense of the City unless (1) the Service Provider and the City shall have mutually agreed to the contrary, (2) the Service Provider has failed within a reasonable time to retain counsel reasonably satisfactory to the City, or (3) the City and the Service Provider are both name parties in any such proceeding and, in the sole judgment of the City, representation of both the City and the Service Provider by the same counsel would be inappropriate due to actual or potential differing interests between them. The indemnification provisions of Section 14 shall survive the expiration or earlier termination of this Contract with respect to any acts or omissions occurring during the term of the Contract. Notwithstanding anything contained in the foregoing indemnity, any claim for indemnity by the City for claims of third parties alleging harm due to the professional services provided by Service Provider, to the fullest extent permitted by law, Service Provider shall indemnify City from and against losses, damages, and judgments arising from such claims by third parties, including reasonable attorneys' fees and expenses recoverable under applicable law, but only to the extent they are found to have been caused by a negligent act, error or omission of Service Provider or its sub-Service Providers in the performance of professional services under this Agreement.

- 13.2 In addition to indemnification provisions stated above, if the City's use of any service, software, firmware, programming, or other item provided by or on behalf of the Service Provider is enjoined due to infringement of another person or entity's intellectual property rights, the Service Provider shall promptly, at its sole cost and expense, modify the infringing item so that it no longer infringes, procure for the City the legal right to continue using the infringing item, or procure for the City a non-infringing item, or procure for the City a non-infringing replacement item having equal or greater functional capabilities as the infringing item.
- 13.3 The Service Provider shall assume all responsibility for loss caused by neglect or violation of any state, federal, municipal or agency law, rule, regulation or order. The Service Provider shall give to the proper authorities all required notices relating to its performance, obtain all official permits and licenses, and pay all proper fees and taxes. It shall promptly undertake proper monetary restitution with respect to any injury that may occur to any building, structure or utility in

EXHIBIT A

GENERAL CONDITIONS

consequence of its work. The Service Provider will notify the City in writing of any claim made or suit instituted against the Service Provider because of its activities in the performance of the Contract.

- 13.4 No recourse under or upon any obligation, covenant or agreement contained in this Contract, or any other agreement or document pertaining to the work or services of the Service Provider hereunder, as such may from time to time be altered or amended in accordance with the provisions hereof, or any judgment obtained against the City, or by the enforcement of any assessment or by any legal or equitable proceeding by virtue of any statute or otherwise, under or independent of this Contract, shall be had against any member (including without limitation members of the City's Council, or members of the citizens advisory committees of each), any officer, employee or agent, as such, past, present, or future of the City, either directly or through the City or otherwise for any claim arising out of or in connection with this Contract or the work or services conducted pursuant to it, or for any sum that may be due and unpaid by the City. Any and all personal liability of every nature, whether at common law or in equity, or by statute or by constitution or otherwise, of any such member, officer, employee, or agent, as such, to respond by reason of any act or omission on his or her part or otherwise for any claim arising out of or in connection with this Contract or the work or services conducted pursuant to it, or for the payment for or to the City, or any receiver therefore or otherwise, or any sum that may remain due and unpaid by the City, is expressly waived and released as a condition of and in consideration of the execution of this Contract and the promises made to the Service Provider pursuant to this Contract.
- 13.5 In any and all claims against the City, or any of their officers, members, agents, servants or employees, by any employee of the Service Provider, any subcontractor, anyone directly or indirectly employed by any of them or anyone for whose acts any of them may be liable, the indemnification obligation of the Service Provider under this Section 13 shall not be limited in any way by any limitation on the amount or type of damages, compensation or benefit payable by or for the Service Provider or any subcontractor under Workers' Compensation Acts, disability benefit acts or other employee benefit acts.
- 13.6 No provisions of Section 13 herein shall be construed to negate, abridge, or otherwise reduce any other right of indemnity that the City may have as to any party or person described therein.
- 13.7 Insurance**
- 13.7.1 **General Liability and Automobile Liability.** The Service Provider shall purchase and maintain in force during the term of the Contract, at its own cost and expense, to protect the Service Provider, the City, and the members (including, without limitation, all members of the governing City's Council and the citizens' advisory committees of each), officers agents, and employees of each, from and against any and all liabilities

EXHIBIT A

GENERAL CONDITIONS

arising out of or in connection with the Service Provider's performance of the Contract work:

- (1) Commercial general liability insurance with coverage of not less than ONE MILLION DOLLARS (\$1,000,000.00) combined single limit per occurrence, and with contractual liability coverage for Service Provider's covenants to and indemnification of the City under the Contract, and
- (2) Automobile liability insurance with policy limits of not less than ONE MILLION DOLLARS (\$1,000,000.00) combined single limit per accident or occurrence covering each motor vehicle operated on City property.

13.7.1.1 Self-Insured Retention. Service Provider's commercial general liability insurance policies shall not be subject to a self-insured retention exceeding \$10,000, if the value of the Contract is less than \$1,000,000, and not be subject to a self-insured retention exceeding \$100,000 if the Contract is \$1,000,000 or more unless approved by the City Manager. Service Provider's automobile liability insurance policies shall not be subject to a self-insured retention exceeding \$10,000 unless approved by the City Manager.

13.7.1.2 Additional Insured Endorsement. Service Provider agrees and shall cause the City their member (including, without limitation, members of the City's Council and members of the citizens' advisory committees of each), officers, employees, and agents to be named as additional insured's under such policy or policies of commercial general and automobile liability insurance.

13.7.1.2 Workers' Compensation and Employer's Liability. If Service Provider has any employee working on City property, Service Provider shall procure and maintain in force during the term of the Contract (i) workers' compensation insurance, and (ii) employer's liability insurance. The policy limits of the Service Provider's employer's liability insurance shall not be less than \$100,000 for "each employee." If the Service Provider is self-insured, the Service Provider shall provide proof of self-insurance and authorization to self-insure as required by applicable state laws and regulations.

13.7.3 Professional Liability Insurance. The Service Provider shall purchase and maintain in force during the term of the Contract, Professional Liability insurance which will pay for damages arising out of errors or omissions in the rendering, or failure to render professional services under the Contract in the amount of at least ONE MILLION DOLLARS (\$1,000,000.00) per claim. Such insurance must contain nose and tail coverage to include work performed by the Service Provider from the project's inception

EXHIBIT A

GENERAL CONDITIONS

date and until such time as the Statute of Limitations has run for the work done on the project.

13.7.4 Health Insurance. Not applicable.

13.7.5 Garage Liability Insurance. Not applicable.

13.7.6 Garage Keeper's Legal Liability Insurance. Not applicable.

13.7.7 Crime Coverage. Not applicable.

13.7.8 Pollution Liability Insurance. Not applicable.

13.7.9 Deductibles. The Service Provider's policies of insurance required by this Section 13.7 may require the Service Provider's payment of a deductible, provided the Service Provider's insurer is required to pay claims from the first dollar at 110% of the claim value without any requirement that the Service Provider pays the deductible prior to its insurer's payment of the claim.

13.7.10 Other Insurance Requirements. All insurance policies required by this Section 13.7 shall be provided that they are primary insurance with respect to any other valid insurance the City may possess and that any other insurance the City does possess shall be considered excess insurance only. All such insurance shall be carried with a company or companies which meet the requirements of Section 14.2 of these General Conditions and said policies shall be in a form satisfactory to the City. A properly completed and executed Certificate of Insurance on a form provided or approved by the City (such as a current ACORD certificate of insurance) evidencing the insurance coverage required by this Section shall be furnished to the City upon the Service Provider shall provide the City with at least thirty (30) days' prior written notice of any adverse material change in the Service Provider's required insurance coverage except that ten (10) days' notice of cancellation for non-payment is required. For purposes of this Section 13.7.10, and "adverse material change" shall mean any reduction in the limits of the insurer's liability, any reduction, non-renewal or cancellation of any insurance coverage, or any increase in the Service Provider's self-insured retention. Prior to the expiration of any such policy, the Service Provider shall file with the City a certificate of insurance showing that such insurance coverage has been renewed. If the insurance coverage is canceled or reduced, the Service Provider shall, within five (5) days after such cancellation or reduction in coverage, file with the City a

EXHIBIT A

GENERAL CONDITIONS

certificate showing that the required insurance has been reinstated or provided through another insurance company or companies approved by the City. If the Service Provider fails to obtain or have such insurance reinstated, the City may, if it so elects, and without waiving any other remedy it may have against the Service Provider, immediately terminate this Contract upon written notice to the Service Provider. The City Manager shall have the right to alter the monetary limits or coverage herein specified from time to time during the term of this Contract, and the Service Provider shall comply with all reasonable requests of the City Manager with respect thereto.

14. LIABILITY INSURANCE

- 14.1 The Contractor shall be required to provide the bonds as dictated in the Procurement Documents in Exhibit D.
- 14.2 Liability Insurance Companies furnishing insurance coverage required by these General Conditions shall (a) be approved to issue insurance policies in the State of Georgia, and (b) must have no less than a "B+" Financial Rating and a Financial Size Category of "Class VI" or higher according to the most current edition of A.M. Best's Insurance Reports. If the liability insurer is rated by A.M. Best's Insurance Reports at an "A- Financial Rating and a Financial Size Category of "Class VIII" or higher than the City Manager may waive the requirement for the insurer to be approved by the State of Georgia.

15. CONTRACT ADJUSTMENTS

- 15.1 Notwithstanding any provision herein to the contrary, the City reserves the right to modify at any time the nature, method, scope, frequency, or timing of the Service Provider's obligations under this Contract (Contract Adjustments) in whatever manner it determines to be reasonably necessary for the proper completion of the Service Provider's work hereunder. Both parties agree that, should any Contract Adjustments be made, the Service Provider's compensation will be adjusted accordingly, in such amount or amounts as will be mutually agreed to by means of good-faith negotiation by the City and Service Provider and, to the extent possible, by reference to any unit costs already established in the Proposal. Without exception, all deletion or additions to the scope of work will be set forth in a written Amendment to this Contract.
- 15.2 Notwithstanding the foregoing, the City shall have the right to terminate this Contract herein should the Service Provider and the City fail to reach agreement on the adjusted compensation within thirty (30) days after the date of the Contract Adjustment.
- 15.3 Notwithstanding the foregoing, there shall be no upward adjustment of the compensation on account of any Contract Adjustment made necessary or appropriate as a result of the mismanagement, improper act, or other failure of the Service Provider, its employees, agents, or its subcontractors to properly perform its obligations and functions under this Contract.

GENERAL CONDITIONS

16. SUBCONTRACTORS

16.1 The Service Provider shall perform all of its obligations and functions under this Contract by means of its own employees, or by a duly qualified subcontractor which is approved in advance by the City. Such subcontractor which is an affiliate, parent, or subsidiary company; or had principal owners, relative, management, or employees common to the Service Provider; or any other party that has the ability to significantly influence the management or daily business operations of the subcontractor must be disclosed in writing to the City Manager. Goods and services provided by subcontractors which are reimbursed by the City must be bona fide arm's-lengths transactions. In the event a subcontractor is employed, the Service Provider shall continuously monitor the subcontractor's performance, shall remain fully responsible to ensure that the subcontractor performs as required and itself performs or remedy any obligations or functions which the subcontractor fails to perform properly.

Nothing contained herein shall be construed to prevent the Service Provider from using the services of a common carrier for delivering goods to the City. The City approves the sub-Service Providers listed in the Statement of Qualifications.

16.2 This Contract shall be referred to and incorporated within any contractual arrangement between the Service Provider and a subcontractor and, in such contractual arrangement; the subcontractor shall give its express written consent to the provisions of this Section 16. To the extent feasible, the provisions of this Contract shall apply to any such subcontractor in the same manner as they apply to the Service Provider. However, such application shall neither make any subcontractor a party to this Contract nor make such subcontractor a third-party beneficiary hereof.

16.3 In the event that the Service Provider employs a subcontractor, then the City may require that copies of invoices for all work (including invoices submitted to the Service Provider for work performed by a subcontractor) shall be submitted to the City by the Service Provider and the City shall pay all compensation to the Service Provider. It shall be the sole responsibility of the Service Provider to deal with a subcontractor with respect to the collection and submission of invoices and the payment of compensation. In no event shall the City have any obligation or liability hereunder to any subcontractor, including, in particular, any obligations of payment.

17. DEFAULT AND TERMINATION

17.1 In the event that:

17.1.1 the Service Provider shall fail to keep, perform or observe any of the promises, covenants or agreements set forth in this Contract (provided that notice of the first failure shall have been given to the Service Provider, but whether or not the Service Provider shall have remedied any such failure); or

17.1.2 the Service Provider shall fail to keep, perform or observe any promise, covenant, or agreement set forth in this Contract, and such failure shall continue for a period of more than five (5) days after delivery to the Service Provider of a written notice of such breach or default; or

EXHIBIT A

GENERAL CONDITIONS

- 17.1.3 the Service Provider's occupational or business license shall terminate, or the Service Provider shall fail to provide the City with any bond, letter of credit, or evidence of insurance as required by the Contract Documents, for any reason; or
- 17.1.4 the Service Provider fails for any reason to provide the City with an acceptable renewal or replacement bond or letter of credit within the time period specified by a provision for this Contract; or
- 17.1.5 the Service Provider shall become insolvent, or shall take the benefit of any present or future insolvency statute, or shall make a general assignment for the benefit of creditor, or file a voluntary petition in bankruptcy or a petition or answer seeking an arrangement for its reorganization, or the readjustment of its indebtedness under the Federal Bankruptcy laws, or under any other law or statute of the United States or any State thereof, or shall consent to the appointment of a receiver, trustee or liquidator of all or substantially all of its property; or
- 17.1.6 the Service Provider shall have a petition under any part of the Federal Bankruptcy laws, or an action under any present or future insolvency laws or statute filed against it, which petition is not dismissed within thirty (30) days after the filing thereof; or
- 17.1.7 there is an assignment by the Service Provider of this Contract or any of the Service Provider's rights and obligations hereunder for which the City has not consented in writing; or
- 17.1.8 the Service Provider shall default on any other agreement entered into by and between Service Provider and the City, then, in its discretion, the City shall have the right to terminate this Contract for default, which termination shall be effective upon delivery of written notice of such termination to the Service Provider. In the event that the City terminates this Contract for default, or the Service Provider abandons or wrongfully terminates the Contract, the Service Provider shall be paid for compensation earned to the date of termination or abandonment (but the City shall have the right to reduce by off-set any amounts owed to the Service Provider hereunder or under any other Contract or obligation by the amount of the City's damages and any amounts owed by the Service Provider to the City), but the Service Provider shall not be compensated for any profits earned or claimed after the receipt of the City's notice of termination by default or after abandonment or wrongful termination. The City's election to terminate or not to terminate this Contract in part or whole for the Service Provider's default shall in no way be construed to limit the City's right to pursue and exercise any other right or remedy available to it pursuant to the terms of the Contract or otherwise provided by law or equity.
- 17.2 Notwithstanding anything else herein contained, the City may terminate this Contract in whole or in part at any time for its convenience by giving the Service Provider thirty (30) days written notice. In that event, the Service Provider shall proceed to complete any part of the work, as directed by the City, and shall settle all its claims and obligations under the Contract, as directed by the City. The Service Provider shall be compensated by the City in accordance with the

GENERAL CONDITIONS

provisions hereof, including in particular Section 2 of these General Conditions, provided, however, that in no event shall Service Provider be entitled to compensation for work not performed or for anticipatory profits. Service Provider shall justify its claims, as requested by the City, with accurate records and data.

17.3

Bankruptcy and Liquidation – In the event the Service Provider (1) makes an assignment for the benefit of creditors, or petition or apply to any tribunal for the appointment of a custodian, receiver, or trustee for all or a substantial part of its assets; (2) commences any proceeding under any bankruptcy, reorganization, arrangement, readjustment of debt, dissolution, or liquidation law or statute of any jurisdiction whether now or hereafter in effect; (3) has had any such petition or application filed or any such proceeding commenced against it in which an order for relief is entered or an adjudication or appointment is made, and which remains undismissed for a period of sixty(60) days or more; (4) takes any corporate action indicating its consent to, approval of, or acquiescence in any such petition, application, proceeding, or order for relief or the appointment of a custodian, receiver, or trustee for all or substantial part of its assets; or (5) permits any such custodianship, receivership, or trusteeship to continue undischarged for a period of sixty (60) days or more causing the Service Provider or any third party, including, without limitation, a trustee in bankruptcy, to be empowered under state or federal law to reject this Contract or any agreement supplementary hereto, the City shall have the following rights:

(i) In the event of a rejection of this Contract or any agreement supplementary hereto, the City shall be permitted to retain and use any back-up or archival copies of the software licensed hereunder under this Agreement for the purpose of enabling it to mitigate damages caused to the City because of the rejection of this Contract. The City shall exert reasonable efforts to mitigate such damage by use of such back-up or archival copies.

(ii) In the event of rejection of this Contract or any agreement supplementary hereto, the City may elect to retain its rights under this Contract or any agreement supplementary hereto as provided in Section 365(n) of the Bankruptcy Code.

Upon written request of the City to, as applicable, the Service Provider or the bankruptcy trustee or receiver. The Service Provider or such bankruptcy trustee or receiver shall not interfere with the rights of the City as licensee as provided in this Contract or in any agreement supplementary hereto to obtain the Source Material(s) from the bankruptcy trustee and shall, if requested, cause a copy of such Source Material (s) to be available to the City.

(iii) In the event of rejection of this Contract or any agreement supplementary hereto, the City may elect to retain its rights under this Contract or any agreement supplementary hereto as provided in section 365(n) of the Bankruptcy Code without prejudice to any of its rights of setoff with respect to this Contract under the Bankruptcy Code or applicable non-bankruptcy law; or In the event of a rejection of this Contract or any agreement supplementary hereto,

EXHIBIT A

GENERAL CONDITIONS

the City may retain its rights under this Contract or any agreement supplementary hereto as provided in section 365(n) of the Bankruptcy Code without prejudice to any of its right under section 503(b) of the Bankruptcy Code.

18. CITY'S AUTHORIZED REPRESENTATIVE

During the term of this Contract, the City manager or designee may from time to time designate an individual to serve as the City's Authorized Representative (CAR) and an Assistant CAR designated to serve in that capacity in the absence of the CAR, who shall have such authority to act on the City's behalf as the City Manager may from time to time actually delegate to such person, but in no event shall the CAR have authority to modify or terminate this Contract, or make final decisions with respect to amendments, time extensions, assignments, cost or payment adjustments or payment disputes.

19. ASSIGNMENT

Neither this Contract nor any of the Service Provider's rights or obligations hereunder may be assigned by the Service Provider without the City's prior written consent, which consent may be granted or withheld at the City's sole discretion. Any transfer of this Contract by merger, consolidation or liquidation (unless the stock of the Service Provider is traded on a national stock exchange or in a generally recognized over the counter securities market) any change in ownership of a power to vote a majority of the outstanding voting stock or ownership interests of the Service Provider shall constitute an assignment of this Contract for purposes of this Section. In the event the Service Provider assigns or subcontracts or attempts to assign or subcontract any right or obligation arising under this Contract without City's prior written consent, the City shall be entitled to terminate this Contract pursuant to the provisions of Section 17 hereof.

20. NOTICES

20.1 Unless otherwise stated herein, all notices or other writings which the City is required or permitted to give to the Service Provider may be hand-delivered, mailed via U.S.

Certified Mail or sent next-day delivery by a nationally-recognized overnight delivery service to the Service Provider's address set forth in the Proposal. Any such notice shall be deemed to have been delivered upon actual delivery, or one (1) day following submission to a nationally-recognized overnight delivery service for next day delivery to the Service Provider, or three (3) days following submission to the Service Provider by U.S. Certified Mail.

20.2 Unless otherwise stated herein, all notices or other writings which the Service Provider is required or permitted to give to the City may be hand-delivered to the City Manager, mail via U.S. Certified Mail. Or sent next-day delivery by a nationally-recognized overnight delivery service for next day delivery to City or three (3) days following submission to the City by U.S. Certified Mail. Any such notice shall be sent to:

City of Brookhaven, GA
ATTN: City Manager
4362 Peachtree Road NE
Brookhaven, GA 30319

GENERAL CONDITIONS

Service Provider

20.3 Either party may change its notice address by written notice to the other given as provided in this section.

21. NONDISCRIMINATION

21.1 During the performance of this Contract, the Service Provider, for itself, its assignees and successors in interest agrees as follows:

21.1.1 Compliance with Regulations. The Service Provider shall comply with the Law and Regulations as they may be amended from time to time (hereafter referred to as the “Regulations”), which are herein incorporated by reference and made a part of this Contract.

21.1.2 Nondiscrimination. The Service Provider, with regard to the work performed by it during the Contract, shall not discriminate on the grounds of race, color, or national origin in the selection and retention of any subcontractor, including procurement of materials and leases of equipment. The Service Provider shall not participate either directly or indirectly in the discrimination prohibited by the Regulations.

21.1.3 Solicitations for Subcontracts, Including Procurement of Materials and Equipment. In all solicitations either by competitive proposing or negotiation made by the Service Provider for work to be performed under a subcontract, including procurement of materials or leases of equipment, each potential subcontractor or supplier shall be notified by the Service Provider of the Service Provider’s obligations under this Contract and the Regulation relative to nondiscrimination on the grounds of race, color or national origin.

21.1.4 Information and Reports. The Service Provider shall provide all information and reports required by the Regulations or directives issued pursuant thereto and shall permit access to its books, records, accounts, other sources or information, and its facilities as may be determined by the City to be pertinent to ascertain compliance with such regulations, orders, and instructions, the Service Provider shall so certify to the City, as appropriate, and shall set forth what efforts it has made to obtain the information.

21.1.5 Sanctions for Noncompliance. In the event of the Service Provider’s noncompliance with the nondiscrimination provisions of this Contract, the City shall impose such Contract Sanctions as it may determine to be appropriate, including but not limited to:

EXHIBIT A

GENERAL CONDITIONS

21.5.1 Withholding of payments to the Service Provider under the Contract until the Service Provider complies, and/or

21.5.2 Cancellation, termination or suspension of the Contract, in whole or in part.

21.1.3 Incorporation of Provisions, The Service Provider shall include the provisions of subsections 21.1.1 through 21.1.5 in every subcontract, including procurement of materials and leases of equipment, unless exempt by the Regulations or directives issued pursuant thereto. The Service Provider shall take such action with respect to any subcontractor procurement as the City may direct as a means of enforcing such provisions including sanctions for noncompliance. Provided, however, that in the event the Service Provider becomes involved in, or is threatened with, litigation with a subcontractor or supplier as a result of such direction, the Service Provider may request the City to enter into such litigation to protect the interest of the City and, in addition, the Service Provider may request the interest of the City and, in addition, the Service Provider may request the United States to enter into such litigation to protect the interests of the United States.

21.2 The Service Provider assures the City that it will comply with the pertinent statutes, Executive Orders and such rules as are promulgated to assure that no person shall, on the grounds of race, creed, color, national origin sex, age, marital status, or handicap be excluded from participating in any activity conducted with or benefiting from Federal assistance. This provision shall bind the Service Provider from the period beginning with the initial solicitation through the completion of the Contract.

22. COPYING DOCUMENTS

The Service Provider hereby grants the City and its agent's permission to copy and distribute any and all materials and documents contained in, comprising, or which are otherwise submitted to the City with or in connection with the Service Provider's Proposal or which are contained in the Contract Documents (the "Submittals"). The permission granted by the Service Provider shall be on behalf of the Service Provider and any and all other parties who claim any rights to any of the materials or documents comprising the Submittals. Such permission specifically authorizes the City and its agents to make and distribute such copies of the Submittals or portions thereof as may be deemed necessary or appropriate by the City for its own internal purposes or for responding to requests for copies from any member of the public regardless of whether the request is specifically characterized as a public records request pursuant to Georgia Code. This provision shall survive the expiration or termination of the Contract.

23. GENERAL PROVISIONS

23.1 The Contract Documents consist of the Contract, the Proposal Forms, the Instructions to Proposers, Request for Qualifications, all Addendum(s) issued prior to execution of this Contract, these General Conditions, and Specifications. Together, these documents comprise the Contract and all the documents are fully a part of the Contract as if attached

EXHIBIT A

GENERAL CONDITIONS

to the Contract or repeated herein. Precedence of the Contract Documents shall be as follows: (i) addendum(s) to the Contract Documents, (ii) the Contract, (iii) the General Conditions, (iv) the Scope of Work in Exhibit B, (v) the Invitation to Bid, and (vii) the Bid Form.

- 23.2 This Contract represents the entire agreement between the parties in relation to the subject matter hereof and supersedes all prior agreements and understandings between such parties relating to such subject matter, and there are no contemporaneous written or oral agreements, terms or representation made by any party other than those contained herein. No verbal or written representations shall be relied upon outside the Contract terms and amendments. Without exception, all deletions or additions to the scope of work will be set forth in a written amendment to this Contract. No amendment, modification, or waiver of this Contract, or any part thereof, shall be valid or effective unless in writing signed by the party or parties sought to be bound or charged therewith; and no waiver of any breach or condition of this Contract shall be deemed to be a waiver of any other subsequent breach or condition, whether of a like or different nature.
- 23.3 The Service Provider shall, during the term of this Contract, repair any damage caused to real or personal property of the City and/or its tenants, wherever situated, caused by the intentional, reckless, or negligent acts or omissions of the Service Provider's officers, agents, or employees, and any subcontractors and their officers, agents, or employees, or, at the option of the City, the Service Provider shall reimburse the City for the cost of repairs thereto and replacement thereof accomplished by or on behalf of the City.
- 23.4 The Service Provider warrants to the City that no work performed or materials purchased pursuant to the Contract, whether by, from, or through the Service Provider or a subcontractor, shall cause any claim, lien or encumbrance to be made against any property of the City, and the Service Provider shall indemnify and save the City harmless from and against any and all losses, damages and costs, including attorneys' fees, with respect thereto. If any such claim, lien or encumbrance shall be filed, the Service Provider shall, within thirty (30) days after notice of the filing thereof, cause the same to be discharged of record by payment, deposit, bond, an order of a court of competent jurisdiction or otherwise. This provision shall survive the expiration or termination of the Contract.
- 23.5 The language of this Contract shall be construed according to its fair meaning, and not strictly for or against either the City or the Service Provider. This Contract shall be deemed to be made, construed and performed according to the laws of the State of Georgia. Any suit or proceeding initiated for the purpose of interpreting or enforcing any provision of this Contract or any matter in connection therewith shall be brought exclusively in a court of competent jurisdiction in DeKalb County, Georgia, and the Service Provider waives any venue objection, including, but not limited to, any objection that a suit has been brought in an inconvenient forum. The Service Provider agrees to submit to the jurisdiction of the Georgia courts and irrevocably agrees to acknowledge service of process when requested by the City.

EXHIBIT A

GENERAL CONDITIONS

- 23.6 The section headings herein are for the convenience of the City and the Service Provider and are not to be used to construe the intent of this Contract or any part thereof or to modify, amplify, or aid in the interpretation or construction of any of the provisions hereof.
- 23.7 The use of any gender herein shall include all genders, and the use of any number shall be construed as the singular or the plural, all as the context may require.
- 23.8 The delay or failure of the City at any time to insist upon performance of any of the terms, conditions, and covenants herein shall not be deemed a waiver of that breach or any subsequent breach or default in the terms, conditions, or covenants of this Contract. The Service Provider shall not be relieved of any obligation hereunder on account of its failure to perform by reason of any strike, lockout, or other labor disturbance.
- 23.9 If the City shall, without any fault, be made a party to any litigation commenced between the Service Provider and a third party arising out of the Service Provider's operations and activities at the premises, then the Service Provider shall pay all costs and reasonable attorney's fees incurred by or imposed upon the City in connection with such litigation for all trial and appellate proceedings. The City shall give prompt notice to the Service Provider of any claim or suit instituted against it by such third party. The provisions of this Section supplement and are not intended to be in lieu of the indemnification provisions of Section 5 hereof. The provisions of this Section shall survive the acceptance of the services and payment, therefore, and the expiration or earlier termination of this Contract.
- 23.10 The City shall have the right to recover from the Service Provider all of the City's costs and expenses incurred in enforcing the provisions of this Contract including, but not limited to, (1) the cost of administrative investigation and enforcement (including, without limitation, audit fees and costs, attorneys' fees) and (2) the cost of any trial, appellate or bankruptcy proceeding (including, without limitation, investigation costs, audit fees and costs, attorney's fees, court costs, paralegal fees and expert witness fees). This provision shall survive the expiration or termination of the Contract.
- 23.11 The Service Provider shall not during the term of the Contract knowingly hire or employ (on either a full-time or part-time basis) any employee of the City.
- 23.12 The Service Provider shall be required, during the term of the Contract at no additional cost to the City, to take such reasonable security precaution with respect to its operations at City Hall as the City in its discretion may from time to time prescribe. The Service Provider shall comply with all regulations, rules, and policies of any governmental authority, including the City, relating to security issues.
- 23.13 The City may, but shall not be obligated to, cure, at any time, upon five (5) days written notice to the Service Provider (provided, however, that in any emergency situation to the City shall be required to give only such notice as is reasonable in light of all the circumstances), any default by the Service Provider under this Contract; whenever the City so cures a default by the Service Provider, all costs and expenses incurred by the

EXHIBIT A

GENERAL CONDITIONS

City in curing the default, including but not limited to, reasonable attorneys' fees, shall be paid by the Service Provider to the City on demand.

- 23.14 The City shall, in its discretion, be entitled to deduct from the compensation to which the Service Provider is otherwise entitled hereunder, an amount equal to any liabilities of the Service Provider to the City which is then outstanding. In the event that additional work beyond the scope of this Contract is requested by the City Manager and it results in any extra charges to the City, the Service Provider shall so advise the City in writing of the amount of the extra charges. The City is not required to pay any extra charges for additional work unless such work and the charges, therefore, have been approved in advance and have been confirmed in writing within twenty-four (24) hours by the City Manager, in his or her exclusive discretion.
- 23.15 The Service Provider is an Independent Service Provider, and nothing contained herein shall be construed as making the Service Provider an employee, agent, partner or legal representative of the City for any purpose whatsoever. The Service Provider acknowledges that it does not have any authority to incur any obligations or responsibilities on behalf of the City and agrees not to hold itself out as having any such authority. Nothing contained in this Contract shall be construed to create a joint employer relationship between the City and the Service Provider with respect to any employee of the Service Provider or of its subcontractors.
- 23.16 The Service Provider and its subcontractors if any, shall maintain complete and accurate books and records in accordance with generally accepted accounting principles, consistently applied, and shall be in a form reasonably acceptable to the City Manager or designee. The Service Provider and its subcontractors shall account for all expenses of any nature related to transactions in connection with the Contract in a manner which segregates in detail those transactions from other transactions of the Service Provider and subcontractors and which support the amounts reported and /or invoiced to the City. At a minimum, the Service Provider's and subcontractor's accounting for such expenses and transactions shall include such records in the form of electronic media compatible with or convertible to a format compatible with computers utilized by the City at its offices; a computer run hard copy; or legible microfilm or microfiche, together with access to the applicable reader. All such books and records and computerized accounting systems shall upon reasonable notice from the City be make available in Dekalb County, Georgia, for inspection, examination, audit and copying by the City through and by its duly authorized representatives at any time for up to four (4) years after the year to which books and records pertain. Such inspection, examination, or audit may include but is not limited to a review of the general input, processing and output controls of information systems, using read-only access, for all computerized applications used to record financial transactions and information. The Service Provider and subcontractor shall freely lend its own assistance in a timely manner in making such inspection, examination, audit, or copying and, if such records are maintained in electronic and other machine-readable formats, shall provide the City and/or its representative such assistance as may be required to allow complete access to such records. The City Manager may require the Service Provider and subcontractors to provide other records the City Manager, in his or her sole

EXHIBIT A

GENERAL CONDITIONS

discretion, deems necessary to enable the City to perform an accurate inspection, examination or audit of expenses incurred in and transactions related to performance of this Contract. Such records shall be provided within thirty (30) days or request thereof. In the event that expenses incurred or reimbursed are found by such inspection, examination, or audit to have been overpaid, the Service Provider and its subcontractors agree that such amounts shall be payable to the City. If, prior to the expiration of the above-state four (4) year record retention period, an audit or investigation is commenced by the City, or any claim is made or litigation commenced relating to this Contract by the City, the Service Provider, or third party, the Service Provider shall continue to maintain all such records, and the City shall continue to have the right to inspect such records in the manner stated above, until the inspection, examination, audit, claim, or litigation is finally resolved (including the determination of any and all appeals or the expiration of time for an appeal). This provision shall survive the expiration or earlier termination of this Contract. In the event of any conflict between any provision of this Contract and generally accepted accounting principles or generally accepted auditing standards, the provisions of this Contract shall control even where this Contract references such provisions or standards. In particular, without limitation, the Service Provider and subcontractors shall maintain all records required under this Contract to the full extent required hereunder, even if some or all such records would not be required under such generally accepted accounting principles or auditing standards. If as a result of an inspection, examination or audit, it is established that amounts are due from the Service Provider to the City, the Service Provider shall forthwith, upon written demand from the City, pay the City such amount, together with interest on the amount due at the rate of twelve (12%) percent per annum, or if less, the maximum rate of interest allowed by law, from the date such additional amounts were overpaid by the City. Further, if such inspection, examination or audit establishes that the Service Provider has overbilled such amounts for any Contract period by two (2%) percent or more, then the entire expense of such inspection, examination or audit shall be paid by the Service Provider.

- 23.17 The Service Provider and subcontractors shall prepare and provide the City with all detailed reports as required under the Contract on a timely basis. The City reserves the right to modify the reporting procedures or the form and content of any report as it deems necessary.
- 23.18 There are no third-party beneficiaries to this Contract, and nothing contained herein shall be construed to create such.
- 23.19 Time is of the essence for the performance of each of the Service Provider's obligations under this Contract.
- 23.20 In computing any period of time established under this Contract, except as otherwise specified herein the word "days" when referring to a period of time is ten (10) days or less means business days, and when referring to a period of time that is more than ten (10) days means calendar days. The day of the event, from which the designated period of time begins to run shall not be included. A business day is any day other than Saturday, Sunday, or Federal, State of Georgia or City holidays.

EXHIBIT A

GENERAL CONDITIONS

- 23.21 The Service Provider agrees to perform all acts and execute all supplementary instruments or documents which may be reasonably necessary to carry out or complete the transaction(s) contemplated by this Contract.
- 23.22 The City reserves the right to further develop, improve, repair and alter the facilities and all roadways, and parking areas, as it may reasonably see fit, free from any and all liability to the Service Provider for loss of business or damages of any nature whatsoever to the Service Provider occasioned during the making of such improvements, repairs, alterations and additions, including, but not limited to, any damages resulting from negligence of the City or its employees, agents or Service Providers.
- 23.23 The Service Provider and the City hereby mutually waive any claim against each other and their respective members, officials, officers, agents and employees for damages (including damages for loss of anticipated profits) caused by any suit or proceedings brought by either of them or by any third party directly or indirectly attacking the validity of this Contract or any part thereof, or any addendum or amendment hereto, or the manner in which this Contract was solicited, awarded or negotiated, or arising out of any judgment or award in any suit or proceeding declaring this Contract, or any addendum or amendment hereto, null, void or voidable or delaying the same, or any part thereof, from being carried out.
- 23.24 At the option of the Service Provider, the products and/or services provided under the Contract resulting from this solicitation may be provided to other governmental agencies, including the State of Georgia, its agencies, political subdivisions, counties and cities under the same terms and conditions, including price, as such products and/or services are provided under this Contract. Each governmental agency allowed by the Service Provider to purchase products and/or services in connection with this Contract shall do so independent of the City or any other governmental entity. Each agency shall be responsible for its own purchases and shall be liable only for goods and services ordered, received and accepted by it. The City shall have no liability to Service Provider or any governmental agency resulting from the purchase by that agency of products and /or services from the Service Provider in connection with this Contract.
- 24. GRATUITIES, REBATES, OR KICKBACKS.**
- 24.1 GRATUITIES. It shall be unethical for any person to offer, give or agree to give any employee or official of the City or for any employee or official of the City to solicit, demand, accept from another person, a gratuity, rebate, loan, offer of employment or other services or property of value in connection with any decision, approval, disapproval, recommendation or preparation of any part of a program requirement or a purchase request including the content of any specification or procurement standard, rendering of advice, investigation, auditing or in any other advisory capacity in any particular matter, pertaining to any program requirement or a Contract or subcontract, or to any solicitation or proposal therefore in any manner inconsistent with the State of Georgia's Department of Administrative Services Gratuity Policy. Rebates normally or

EXHIBIT A

GENERAL CONDITIONS

routinely offered to customers in the ordinary course of business for the purchase of goods and services are acceptable and are the property of the City.

- 24.2 **KICKBACK AND REBATES.** It shall be unethical for any payment, gratuity, or offer of employment to be made by or on behalf of a subcontractor to this Contract to the prime contract or higher tie subcontractor, or any person associated therewith, as an inducement for a subcontractor or order.

******* END OF GENERAL CONDITIONS*******

EXHIBIT B

SPECIFICATIONS AND SCOPE OF WORK

Contract Duration:

90 calendar days

Project Description:

The City of Brookhaven is soliciting competitive sealed bids from qualified contractors for **2020 Street Resurfacing** for the Department of Public Works. The contractor must self-perform tasks constituting a minimum of (30%) of the value of the contract. Work will be done in accordance with Georgia Department of Transportation's Standard Drawings, Standard Specifications, and Pay Items Index as standards and specifications for the construction and completion of the work required, except as noted or directed by Engineer.

Scope

2020 Capital Paving Scope: The contractor shall furnish all materials, equipment, and labor to complete the required construction as described in its entirety to the specifications as directed and the terms of this contract including all incidentals as directed by the City of Brookhaven Director of Public Works or his representative. Unless otherwise specified all work shall be completed in accordance with Georgia Department of Transportation Standard Specifications (current edition), by a completion date.

The work locations and descriptions follow but are not limited to:

Milling and Resurfacing

For roads with exposed subgrade after milling occurs, these roads shall pass a proof roll test prior to resurfacing.

- **Bankhill Row from Newbridge Trace to East End (2250 SY)**—Mill at an average depth of 2.5 inches, resurface with 19 mm at a rate of 220 lbs/sy and with 9.5 mm at a rate of 137.5 lbs/sy within contract limits.
- **Daventry Way from Bankhill Row to West End (1200 SY)**--- Mill at an average depth of 2.5 inches, resurface with 19 mm at a rate of 220 lbs/sy and with 9.5 mm at a rate of 137.5 lbs/sy within contract limits.
- **Newbridge Trace from West End to Northeast End (4140 SY)**-- Mill at an average depth of 2.5 inches, resurface with 19 mm at a rate of 220 lbs/sy and with 9.5 mm at a rate of 137.5 lbs/sy within contract limits.
- **Chalfont Walk from Osborne Rd to Bankhill Row (1067 SY)**-- Mill at an average depth of 2.5 inches, resurface with 19 mm at a rate of 220 lbs/sy and with 9.5 mm at a rate of 137.5 lbs/sy within contract limits.

EXHIBIT B

SPECIFICATIONS AND SCOPE OF WORK

- **Dunlop Ct from Hearst Dr to Northeast End (680 SY)**-- Mill at an average depth of 2.5 inches, resurface with 19 mm at a rate of 220 lbs/sy and with 9.5 mm at a rate of 137.5 lbs/sy within contract limits.

Full Depth Reclamation (FDR):

| STREET NAME | FROM STREET | TO STREET | Square Yardage |
|--------------------|----------------------|-------------------|-----------------------|
| Berkford Ct | Berkford Cir | EAST END | 1332 |
| Victor Rd | Shady Valley Dr @ CL | EAST END | 2316 |
| Woody Trl | Green Meadows Ln | SE END | 810 |
| Green Meadows Ln | Caldwell Rd | NE End | 7740 |
| Valvedere Dr | N Thompson Rd | NORTH END | 5130 |
| Hasty Ct | WEST END | Candler Lake West | 700 |
| Sunland Dr | Apple Valley Rd | Caldwell Rd | 2273 |
| Shadecrest Dr | Sunland Dr | NORTH END | 800 |
| Saybrook Drive | Windsor Pkwy | Iman Dr | 3465 |
| Wayland Cir | NORTH END | Dresden Dr | 6840 |

Provide full depth reclamation. The reclamation will consist of:

- Pulverizing the existing roadway material to a depth of 10 inches below existing gutter line.
- Clipping and removing the mixed material to finished subgrade which will be 3.25 inches below the gutter line.
- Mixing Portland cement to a depth of 8 inches below the finished subgrade. The cement mixture rate will be 60 lbs/sy or as directed by the Engineer. **It is recommended that the FDR incorporates reclaimed asphalt equal to or greater than 2 inches in depth.**
- Placing a 3.25" asphalt courses after 7 days of curing with moisture conditioning or **3 days** upon the recommendation of Geo-tech test results and approval of Engineer. All FDR roads shall pass a proof roll test prior to resurfacing.

EXHIBIT B

SPECIFICATIONS AND SCOPE OF WORK

For all streets the existing roadway materials should be mixed into the underlying subgrade using a pulvimixer. Access to the residences and businesses must be maintained at all times. 2 inches of 19 mm and 1.25 inch of 9.5 mm asphalt mixes will be placed on the reclaimed base at the unit rates provided in the bid schedule above.

Extension of Contract Pricing to Private Streets in the City of Brookhaven

The City of Brookhaven would like to ask the suppliers to agree to extend identical unit pricing under the same terms to other public entities or other private communities within the city limits in need of paving. This is optional opportunity to the contractor.

Each contracting entity or private community will execute a separate contract with the successful supplier for its requirement. However, any supplier, by written notification at the time of the bid due date and time, may decline to extend the prices and terms of their bid to any, and/or all other public entities or private communities.

The successful supplier, in contracting with another public entity or private community may incur additional costs. All demonstrable costs (shipping, etc.) may be passed on to that public entity or private community, along with sales tax.

The City intends that other public agencies (county, special district, public authority, public agency, school district, private community or other political subdivision of the state of Georgia) shall have the option to participate in any agreement created because of this Invitation to Bid. The City of Brookhaven shall incur no financial responsibility in connection with a purchase order from another public entity or private community. Vendor's agreement or failure to agree to the "piggyback" agreement will not be a factor in the award. This piggyback opportunity will expire when the contracted supplier's contract expires.

General Notes:

1. Work is expected to begin within **10 days** of the official "Notice to Proceed" and all paving work be completed within 90 calendar days.
2. Prior to beginning work the contractor will be required to submit a job mix formula for review and acceptance by the city
3. Scheduling: On a weekly basis, the Contractor shall submit a schedule of work to be performed two (2) weeks in advance (e.g. a two week look ahead).
4. **The contractor will notify all affected residents & stakeholders of upcoming paving construction on each scheduled street, via flyers and/or door hangers 24 to 48 hours prior to mobilization/construction.**
5. **The Contractor shall perform project housekeeping/clean-up on a daily basis: this includes sweeping and/or vacuuming for dust and debris along the roadway and cleaning of driveways if applicable. Cleanliness is a point of emphasis for the City of Brookhaven**

EXHIBIT B

SPECIFICATIONS AND SCOPE OF WORK

and our citizens and great attention must be paid to keeping the streets and properties affected by this work as clean and in order as possible.

6. **The Contractor's performance will be measured based on the following:**
 - **Compliance with the Scope of Work and GDOT Specifications**
 - **Cleanliness of the worksite**
 - **Meeting agreed upon schedule dates**
 - **Submission of all deliverables as specified**
7. The contractor is responsible for calling for utility locations prior to the start of each work. It shall be the contractor's responsibility to coordinate his work with any utility owner whom maybe in conflict with his work. No claims will be considered for extra compensation.
8. Any item which must be removed during the construction work and is not specially called for shall be removed by the contractor. The cost shall be included in other unit price bid. No claims will be considered for extra compensation.
9. All traffic control shall be provided by the contractor in accordance with GDOT's "shelf" Special Provision 150. Assistance from police officers will not be provided by the City, but the contractor shall coordinate with the City of Brookhaven Police Department to provide a work zone officer as needed or directed by the engineer. Traffic control costs shall be included in contract pay items pricing. The contractor shall maintain through traffic via single lane closure while also allowing adequate access to driveways and side roads. At no time will a street be closed completely unless approved and directed by the Engineer. Post mounted traffic control signs are not required. In addition to the required traffic control signs, contractor shall put out city provided "Brookhaven Working for You" signs at each work location during active construction.
10. The City intends to award one contract for this work but reserves the right to divide the work among multiple contractors. The City reserves the right to adjust the number of roads in this contract.
11. It is the intent of this contract for each unit price bid to include all labor, materials, equipment, tools, transportation, and supplies as required as necessary to complete the work in accordance with the plans, specifications as directed, and the terms of this contract. **The contractor should verify the project quantities prior to the award.**
12. The general descriptions of each item of work are as described in the Georgia Department of Transportation's standards and specifications, complete and accepted. Any conflicts which might occur during the course of the construction work or any conflicts which might be related to the compensation of any work shall be decided based on the Georgia DOT's standards and specifications. No claims will be considered for extra compensation.
13. Upon the completion of each work, any excess items which might be left over from the construction related work shall be removed and disposed of properly by the contractor. The

EXHIBIT B

SPECIFICATIONS AND SCOPE OF WORK

cost for such removal and disposal of such items will be included in other unit price bid. No claims will be considered for extra compensation.

14. Under this scope, “Department”, “Engineer”, and “Resident Engineer” shall mean the “City of Brookhaven, Georgia, Public Works Director or City of Brookhaven, Georgia or Public Works Designee”.
15. Working hours are limited to Monday to Friday, 7:00 AM to 7:00 PM, & Saturday 8:00 AM to 5:00 PM, unless prior approval is granted by the Department of Public Works. The contractor will have to give the City Engineer a 72 hour notice prior to working on weekends. Lane closures on non-neighborhood streets will only be permissible between the hours of 9 a.m. and 4 p.m.
16. **The maximum allowable time between milling and placing new pavement will be 48 hours.**
17. The cost for Remove and Reconstruct Speed Hump will include the cost of all labor, equipment, and material (including asphalt and **pavement markings**) to perform the work. Contractor will be responsible for marking the location of the existing speed humps before removal. Contractor may retain and reuse the concrete blocks from the existing speed humps where possible. No additional claims will be considered for providing replacements for damaged blocks. Speed Humps shall be reinstalled within 7 days of paving, subject Section 108 liquidated damages. Speed Humps that are designated to be replaced as raised cross walks will be paid for at the same unit rate for Remove and Reconstruct Speed Hump.
18. Traffic signal loops must be reinstalled within 7 days of paving. The contractor must also notify the engineer when traffic loops are removed, and when they are reinstalled.
19. Temporary striping where required shall follow within twenty-four (24) hours of resurfacing. **Permanent Pavement markings must be installed no sooner than 15 days after paving but no later than 30 days.** If the contractor fails to meet these requirements, the City will remove these items from the contract and deduct from the contract any additional costs incurred by the City regarding completing this work.
20. Marking tape is permissible for temporary pavement markings on milled surfaces and freshly paved asphalt. **All Crosswalks shall be remarked with marking tape IMMEDIATELY upon milling or placement of asphalt.**
21. The pre-marking layout shall be approved by the City prior to temporary or permanent pavement marking.
22. The City’s standard bike lane marking is a preformed, skid resistant thermoplastic marking, Pre-Mark PM602006 with arrow or equivalent product on the GDOT Qualified Products List, QPL-74 list.

EXHIBIT B

SPECIFICATIONS AND SCOPE OF WORK

23. *Undercut Excavation*- If unsuitable material is encountered below the patch depth, the contractor shall remove the unsuitable material and replace it with compacted Graded Aggregate Base (GAB) as directed by the City's engineer. Pay items are included for the excavation, disposal of the unsuitable material, placement of the GAB and compaction of the GAB.
24. *Manhole, Storm Drain Structures and Utility Valve Box Adjustments*-It shall be the Contractor's responsibility to note and mark the location of each utility valve box and manhole cover on the streets prior to resurfacing then locate and adjust each of these after resurfacing. Water utility valve adjustments may be made with adjustable rings and shall conform with DeKalb County Watershed standards. Sewer manhole adjustments shall be made in accordance with DeKalb County Watershed standards. Adjustments shall be completed within 30 days of paving. High and Early strength Concrete shall be used and protected from traffic for a minimum of 3 days with steel plates or other measures. In the event an existing casting or structure is found to be structurally deficient, it shall be reported to the engineer for evaluation.
25. The standard edge mill width will be 6 feet. Existing pavement shall be milled at the gutter line to a depth equal to or greater than the depth of overlay to be installed at a minimum. **The finished grade of the final asphalt at the gutter line shall be no higher than the existing finished grade or as directed by engineer.**
26. A material transfer vehicle is not required unless the plant and mix used require one as noted on GDOT's QPL 45.
27. Contractor shall have all vehicles marked with their company name.
28. The contractor at minimum will conduct, at Brookhaven City Hall, one (1) overall contract pre-construction meeting shortly after award of the contract and one (1) additional meeting with the pavement marking subcontractor prior to pavement marking.
29. The City of Brookhaven will not provide restroom facilities.
30. The Contract shall perform project housekeeping/clean-up on a daily basis. A 24-hour contact must be provided to the City of Brookhaven for all issues as needed in regards to the project for any safety, signage, or other emergency as needed.
31. The contractor shall obtain permission from any private property owner on whose property construction equipment may be parked. Failure to obtain permission from property owners may result in citations. Limited space for parking of equipment may be available at city owned parks, depending on the schedule of events at the park.
32. A week prior to resurfacing with the topping asphalt mix, the contractor shall secure an approved signed job mix formula from the Georgia Department of Transportation for the topping asphalt mix used on this project.
33. Reset Granite Curb shall consist of lifting the existing curb in areas shown on the list below, resetting curb such that the top of curb is 6 inches above finished grade of asphalt, installing

EXHIBIT B

SPECIFICATIONS AND SCOPE OF WORK

GAB and pouring Class B concrete (see Granite Curb detail). The cost for Reset Granite Curb will include the cost of all labor, equipment, and material (including GAB, Class B concrete and Erosion control measures) to perform this work. Erosion control measures shall be provided to stabilize the exposed soil at all times. The exposed soil shall be landscaped smooth, seeded in kind and straw shall be applied to the impacted areas. City has limited supply of granite curb that can be provided to the contractor to replace any damaged existing curb that cannot be reset.

| | |
|------------------|------|
| Green Meadows Ln | 4430 |
| Sunland Dr | 1502 |
| Woody Trl | 434 |
| Wayland Cir | 4210 |
| Victor Rd | 600 |
| Saybrook Drive | 2208 |
| Valvedere Dr | 3100 |

34. The City of Brookhaven reserves the right to extend this contract by mutual consent for a limited period of time, not to exceed six (6) months, and extend the contract for additional work to the awarded vendor. This action should be taken in writing prior to the expiration of the current contract.
35. Proof of Commercial general liability insurance with coverage of not less than ONE MILLION DOLLARS (\$1,000,000.00) combined single limit per occurrence, and with contractual liability coverage for Contractor’s covenants to and indemnification of the City under the Contract.
36. All Bidders are required to submit a Bid Bond or a certified check made payable to the City of Brookhaven in the amount of five percent (5%) of the total amount bid. The Bid Bond or certified check must be enclosed in the envelope with the sealed bid.
37. The awarded bidder will be required to furnish a contract Performance Bond and Payment Bond, each in the sum of 100% of the total amount bid and provide insurance coverage as required by the contract documents. Bonding Company must be licensed to do business in Georgia, licensed to do business by the Georgia Secretary of State, authorized to do business in Georgia by the Georgia Insurance Department, listed in the Department of the Treasury's Publication of Companies Holding Certificates of Authority as Acceptable Surety on Federal Bonds and as Acceptable Reinsuring Companies and have an A.M. Best rating of A-V or higher.
38. The awarded bidder will be required to submit Maintenance Bond valid for 12 months in the amount of the total bid.

EXHIBIT B

SPECIFICATIONS AND SCOPE OF WORK

39. The contractor is required to reconstruct ADA ramps (and adjacent sidewalk when warranted to achieve ADA compliance) located within the contract resurfacing limits to be in compliance with GDOT Special Detail A3 (see detail in the contract). The ADA ramp work will be paid for under pay item 8 inch concrete sidewalk.

*******END EXIHIBIT B*******

EXHIBIT C

INFORMATION REQUESTED TO ASSIST IN THE DETERMINATION OF RESPONSIBILITY

Bidders shall provide the following information on attached sheets; this information shall be submitted with the bid in the format specified. Provide the response, to each section of the information, on a separate sheet of paper, preferably typewritten, and attached to the bid at the time it is submitted. Failure to provide information requested in complete and accurate detail may result in rejection of the bid.

1. History and Organizational Structure of the Firm

Provide a cover letter introducing the company and including the corporate name, address and telephone number of the corporate headquarters and local office. **The name and phone number of one individual who will be the company's primary contact with the City of Brookhaven for contract negotiation and the name of the project manager.** A brief history of the company and the present organizational structure of the firm describing the management organization, permanent employees by discipline, and this project's coordination structure; if the firm is a partnership, indicate the name of all partners; if incorporated indicate where and when. If the Contractor has changed names or incorporation status within the last five (5) years, then please list all of such preceding organizations and a brief reason for the change. Contractor shall also provide a business license indicating that the Contractor can conduct business in Dekalb County, Georgia. Further, Contractor shall provide documentation showing that the Contractor is properly registered to conduct business in the State of Georgia. Contractor acknowledges and agrees that any business license and registration must remain current for the duration of the contract and such documents are material term to this agreement.

2. References

List as references (names, addresses, contact persons and toll-free phone numbers) a minimum of three (3) government municipalities or other clients of similar size and nature to City of Brookhaven for which a project comparable to the scope of this project was completed.

3. Subcontractors

Indicate the names and addresses and degree of utilization of any and all subcontractors which would be used in the performance of this contract.

4. Previous Default

Indicate if you or any predecessor organization have ever defaulted on a contract or denied a bid due to non-responsibility to perform. If so, provide the facts and circumstances. If your firm or any successor organization is now involved in any litigation or in the past ten (10) years have been involved in litigation with owners, please list the parties to the litigation, the civil action number and a brief explanation of the matter.

EXHIBIT D
BOND DOCUMENTS

BONDING REQUIREMENTS

Each bid must be accompanied with a BID BOND (bond only: certified checks or other forms are not acceptable) in an amount equal to five percent (5%) of the base bid, payable to the City of Brookhaven. Said bid bond guarantees the bidder will enter into a contract to construct the project strictly within the terms and conditions stated in this bid and in the bidding and contract documents, should the construction contract be awarded.

The Successful Bidder shall be required to furnish a bond for the faithful performance on the contract and a bond to secure payment of all claims for materials furnished and/or labor performed in performance of the project, both in amounts equal to one hundred percent (100%) of the contract price.

The Successful Bidder shall also be required to furnish a Maintenance Bond, in the amount of one-third (1/3) of the contract price, guaranteeing the repair or replacement caused by defective workmanship or materials for a period of one (1) year from the completion of construction.

Bonds shall be issued by a corporate surety appearing on the Treasury Department's most current list (Circular 570 as amended) and be authorized to do business in the State of Georgia.

Date of Bond must not be prior to date of Contract. If Contractor is a Partnership, all partners shall execute Bond.

EXHIBIT D
BOND DOCUMENTS
BID BOND

KNOW ALL MEN BY THESE PRESENTS, THAT _____

(Name of Contractor) _____

(Address of Contractor) at

(Corporation, Partnership and or Individual) hereinafter called Principal, and _____

(Name of Surety)

(Address of Surety)

A corporation of the State of _____, and a surety authorized by law to do business in the State of Georgia, hereinafter called Surety, are held and firmly bound unto

City of Brookhaven Georgia

(Name of Obligee)

4362 Peachtree Road NE, Brookhaven, Georgia 30319

(Address of Obligee)

herein after referred to as Obligee, in the penal sum of _____ Dollars (\$ _____) in lawful money of the United States, for the payment of which sum well and truly to be made, we bind ourselves, our heirs, executors, administrators and successors, jointly and severally, firmly by these presents.

WHEREAS, the Principal is about to submit, or has submitted, to the City of Brookhaven, Georgia, a proposal for furnishing materials, labor and equipment for:

Invitation to Bid, No. 20-101
Capital Paving Project

WHEREAS, the Principal desires to file this Bond in accordance with law in lieu of a certified Bidder's check otherwise required to accompany this Proposal.

NOW, THEREFORE, the conditions of this obligation are such that if the bid is accepted, the Principal shall within ten days after receipt of notification of the acceptance execute a Contract in accordance with the Bid and upon the terms, conditions, and prices set forth in the form and manner required by the City of Brookhaven, Georgia, and execute a sufficient and satisfactory Performance Bond and Payment Bond payable to the City of Brookhaven, Georgia, each in an amount of 100% of the total Contract Price, in form and with security satisfactory to said the City of Brookhaven, Georgia, and otherwise, to be and remain in full force and virtue in law; and the Surety shall, upon failure of the Principal to comply with any or all of the foregoing requirements within the time specified above, immediately pay to the City of Brookhaven,

EXHIBIT D
BOND DOCUMENTS

Georgia, upon demand, the amount hereof in good and lawful money of the United States of America, not as a penalty, but as liquidated damages.

PROVIDED, FURTHER, that Principal and Surety agree and represent that this bond is executed pursuant, to and in accordance with the applicable provisions of the Official Code of Georgia Annotated, as Amended, including, but not limited to, O.C.G.A. SS 13-10-1, et. Seg. And SS 36-86-101, et. Seg. And is intended to be and shall be constructed as a bond in compliance with the requirements thereof.

Signed, sealed, and dated this _____ day of _____ A.D., 20____

ATTEST:

(Principal Secretary)

(Principal)

(SEAL)

BY: _____

(Witness to Principal)

(Address)

(Address)

(Surety)

ATTEST

BY: _____
(Attorney-in-Fact) and Resident Agent

(Attorney-in-Fact)

(Seal)

(Address)

(Witness as to Surety)

(Address)

EXHIBIT D
BOND DOCUMENTS
PAYMENT BOND

KNOW ALL MEN BY THESE PRESENTS: THAT

(Name of Contractor)

(Address of Contractor)

(Corporation, Partnership or Individual)

Hereinafter called Principal, and

(Name of Surety)

(Address of Surety)

A Corporation of the State of _____ and a surety authorized by law to do business in the State of Georgia, hereinafter called Surety, are held and firmly bound unto:

The City of Brookhaven Georgia

(Name of Obligee)

4362 Peachtree Road NE, Brookhaven, Georgia 30319

(Address of Obligee)

Hereinafter referred to as Obligee; for the use and protection of all subcontractors and all persons supplying labor, services, skill, tools, machinery, materials and/or equipment in the prosecution of the work provided for in the contract hereinafter referred to in the full and just sum of _____ Dollars (\$_____) in lawful money of the United States, for the payment of which sum well and truly to be made, the Principal and Surety bind themselves, their, and each of their heirs, executors, administrators, successors and assigns, jointly and severally, firmly by these presents.

The condition of this obligation is such, as whereas the Principal entered into a certain contract, hereto attached, with the Obligee, dated _____ for _____.

EXHIBIT D
BOND DOCUMENTS

NOW, THEREFORE, the conditions of this obligation are such that if the Principal shall well, truly, and faithfully perform said Contract in accordance to its terms, covenants, and conditions, and shall promptly pay all persons furnishing labor, materials, services, skill, tools, machinery and/or equipment for use in the performance of said Contract, then this obligation shall be void; otherwise, it shall remain in full force and effect.

All persons who have furnished labor, materials, services, skill, tools, machinery and/or equipment for use in the performance of said Contract shall have a direct right of action on this Bond, provided payment has not been made in full within ninety (90) days after the last day on which labor was performed, materials service, skill, tools, machinery, and equipment furnished or the subcontract completed.

PROVIDED FURTHER, that said Surety to this Bond, for value received, hereby stipulates and agrees that no change, extension of time, alterations, or additions, to the terms of the Contract or to the Work to be performed thereunder shall in any way affect its obligation on this bond, and it does hereby waive notice of any such change, extension of time, alterations, or additions to the terms of the Contract or to the work to be performed thereunder.

PROVIDED, HOWEVER, that no suit or action shall be commenced hereunder by any person furnishing labor, materials, services, skill, tools, machinery, and /or equipment having a direct contractual relationship with a subcontractor, but no contractual relationship express or implied with the Principal:

Unless such person shall have given notice to the Principal within 120 days after such person did, or performed the last of the work or labor, or furnished the last of the materials, services, skill, tools, machinery and/or equipment for which claim is made, stating with substantial accuracy the amount claimed and the name of the party to whom the materials, services, skill, tools, machinery, and/or equipment were furnished, or for whom they work or labor was done or performed. Such a notice shall be served by mailing the same by registered mail, postage prepaid, in an envelope addressed to the Principal, at any place where an office is regularly maintained for the transaction of business, or served in any manner in which legal process may be served in the State in which the aforesaid project is located, save that such service need not be made by a public officer, and a copy of such notice shall be delivered to the Oblige, to the person and at the address provided for in the Contract, within five days of the mailing of the notice to the Principal.

PROVIDED FURTHER, that any suit under this Bond must be instituted before the expiration of one year after the acceptance of the public works covered by the Contract by the proper authorities.

PROVIDED FURTHER, that Principal and Surety agree and represent that this bond is executed pursuant to and in accordance with the applicable provision of the Official Code of Georgia Annotated, as amended, including, but not limited to, O.C.G.A. SS 13-10-1, et. Eq. and SS 36-86-101, et. Seg., and is intended to be and shall be construed as a bond in compliance with the requirements, therefore.

EXHIBIT D
BOND DOCUMENTS

Signed, sealed, and dated this _____ day of _____, 2019

ATTEST:

(Principal Secretary)
(Seal)

(Principal)

By: _____

(Witness to Principal)

(Address)

(Surety)

ATTEST

BY:

Agent

(Attorney-in-Fact)

(Seal)

(Address)

(Witness as to Surety)

EXHIBIT D
BOND DOCUMENTS
PERFORMANCE BOND

KNOW ALL MEN BY THESE PRESENTS: THAT

(Name of Contractor)

(Address of Contractor)

(Corporation, Partnership or Individual)

Hereinafter called Principal, and

(Name of Surety)

(Address of Surety)

A Corporation of the State of _____ and a surety authorized by law to do business in the State of Georgia, hereinafter called Surety, are held and firmly bound unto:

The City of Brookhaven, Georgia

(Name of Obligee)

4362 Peachtree Road NE, Brookhaven, GA. 30319

(Address of Obligee)

Hereinafter referred to as Obligee; are held firmly bound unto said Obligee and all persons doing work or furnishing skill, tools, machinery, supplies, or material under or for the purpose of the Contract hereinafter referred to, in the penal sum of: _____ Dollars (\$ _____), in lawful money of United States, for the payment of which sum well and truly to be made, we bind ourselves, our heirs, executors, administrators and successors, jointly and severally, firmly by these presents.

The condition of this obligation is such, as whereas the Principal entered into a certain contract, hereto attached, with the Obligee, dated _____ for: _____.

EXHIBIT D

BOND DOCUMENTS

NOW THEREFORE, the conditions of this obligation are such that if the above-bound Principal shall well, truly, fully and faithfully perform said contract according to its terms, covenants, conditions, and agreements of said contract during the original term of said contract and any extensions thereof that may be granted by the obligee, with or without notice to the Surety, and during the life of any guaranty required under the contract, and shall also well and truly perform and fulfill all the undertakings, covenants, terms, conditions and agreement of any and all duly authorized modifications of said contract that may hereafter be made, then his obligation shall be void, otherwise to remain in full force and effect.

PROVIDED FURTHER, that said Surety to this Bond, for value received, hereby stipulates and agrees that no change, extension of time, alterations, or additions to the terms of the Contract or to the Work to be performed thereunder shall in any way affect its obligation on this bond, and it does hereby waive notice of any such change, extension of time, alterations, or additions to the terms of the Contract or to the work to be performed thereunder.

PROVIDED FURTHER, that Principal and Surety agree and represent that this bond is executed pursuant to and in accordance with the applicable provisions of the Official Code of Georgia Annotated, as amended, including but not limited to O. C.G.A. SS 13-10-1 et. Eq. and SS 36-86-101, et Seg., and is intended to be and shall be construed as a bond in compliance with the requirements thereof.

Signed, sealed, and dated this _____ day of _____, 2019

ATTEST:

(Principal)

(Principal Secretary)

(Seal)

By: _____

(Witness to Principal)

(Address)

(Surety)

EXHIBIT D
BOND DOCUMENTS

ATTEST:

(Attorney-in-Fact) and Resident Agent

(Attorney-in-Fact)

(Seal)

(Address)

(Witness as to Surety)

(Address)

EXHIBIT D
BOND DOCUMENTS
MAINTENANCE BOND

PROJECT NO: _____

BOND NO: _____

KNOW ALL MEN BY THESE PRESENTS that we, _____ as Principal, and _____ as Surety, are held and firmly bound unto the CITY OF BROOKHAVEN, GEORGIA, as Obligee in the sum of one-third of the contract bid for the payment of which said Principal and Surety bind themselves, their heirs, administrators, executors, successors and assigns jointly and severally, firmly by these presents.

WHEREAS, the Principal has entered into an agreement with the City of Brookhaven for the Recreation and Parks Restroom Project. Said work has now been completed and the Obligee desires a maintenance bond guarantee said streets and improvements for a period of one-year beginning _____ and ending _____.

NOW, THEREFORE, THE CONDITION OF THIS OBLIGATION IS SUCH, that if the Principal shall fully indemnify and save harmless the City of Brookhaven from any and all loss, costs, expenses or damages, for any repairs or replacements required because of defective workmanship or materials in said construction, then this obligation shall be null and void; otherwise to be and remain in full force and effect as to any such claim arising within one year from the completion of said construction as set forth in said agreement.

Signed, sealed and dated this _____ day of _____, 2019

Witness:

(Principal)

(Name of Surety Company)

(Attorney-in-fact)

End of Exhibit D.



**EXHIBIT E
GEORGIA SECURITY AND IMMIGRATION COMPLIANCE ACT AFFIDAVIT**

Contractor(s) Name: _____

Address: _____

By executing this affidavit, the undersigned person or entity verifies its compliance with O.C.G.A. § 13-10-91, stating affirmatively that the individual, firm, or corporation which is registered with, is authorized to participate in, and is participating in the federal work authorization program commonly known as E-Verify,* in accordance with the applicable provisions and deadlines established in O.C.G.A. § 13-10-91.

The undersigned person or entity further agrees that it will continue to use the federal work authorization program throughout the contract period, and it will contract for the physical performance of services in satisfaction of such contract only with subcontractors who present an affidavit to the undersigned with the information required by O.C.G.A. § 13-10-91(b).

The undersigned person or entity further agrees to maintain records of such compliance and provide a copy of each such verification to the City of Brookhaven within five (5) business days after any subcontractor(s) is/are retained to perform such service.

E Verify™ Company Identification Number

Date of Authorization

BY: Authorized Officer or Agent
(Name of Person or Entity)

Date

SUBSCRIBED AND SWORN BEFORE
ME ON THIS THE

_____ DAY OF _____, 201_

Notary Public

[NOTARY SEAL]

My Commission Expires: _____

*** or any subsequent replacement** operated by the United States Department of Homeland Security or any equivalent federal work authorization program operated by the United States Department of Homeland Security to verify information of newly hired employees, pursuant to the Immigration Reform and Control Act of 1986 (IRCA), P.L. 99-603.

Subcontractor Affidavit under O.C.G.A. § 13-10-91(b)(3)

By executing this affidavit, the undersigned subcontractor verifies its compliance with O.C.G.A. § 13-10-91, stating affirmatively that the individual, firm or corporation which is engaged in the physical performance of services under a contract with (name of contractor) on behalf of (name of public employer) has registered with, is authorized to use and uses the federal work authorization program commonly known as E-Verify, or any subsequent replacement program, in accordance with the applicable provisions and deadlines established in O.C.G.A. § 13-10-91. Furthermore, the undersigned subcontractor will continue to use the federal work authorization program throughout the contract period and the undersigned subcontractor will contract for the physical performance of services in satisfaction of such contract only with sub-subcontractors who present an affidavit to the subcontractor with the information required by O.C.G.A. § 13-10-91(b). Additionally, the undersigned subcontractor will forward notice of the receipt of an affidavit from a sub-subcontractor to the contractor within five business days of receipt. If the undersigned subcontractor receives notice that a sub-subcontractor has received an affidavit from any other contracted sub-subcontractor, the undersigned subcontractor must forward, within five business days of receipt, a copy of the notice to the contractor. Subcontractor hereby attests that its federal work authorization user identification number and date of authorization are as follows:

Federal Work Authorization User Identification Number

Date of Authorization

Name of Subcontractor

Name of Project

Name of Public Employer

SUBSCRIBED AND SWORN
BEFORE ME ON THIS THE

_____ DAY OF _____, 201_

[NOTARY SEAL]

Notary Public

My Commission Expires: _____

End of Exhibit E.



**EXHIBIT F
DRUG-FREE WORKPLACE**

The undersigned certifies that the provisions of Code Sections 50-24-1 through 50-24-6 of the Official Code of Georgia Annotated, relating to the “Drug-free Workplace Act”, have been complied with in full.

The undersigned further certifies that:

(1) A drug-free workplace will be provided for the Service Provider’s employees during the performance of the Contract; and

(2) Each Service Provider who hires a subcontractor to work in a drug-free workplace shall secure from the subcontractor the following written certification:

“As part of the subcontracting agreement with _____ (Service Provider), _____ (subcontractor) certifies to the Service Provider that a drug-free workplace will be provided for the subcontractor’s employees during the performance of this Contract pursuant to paragraph (7) of the subsection (b) of Code Section 50-24-03.”

Also, the undersigned further certifies that he/she will not engage in the unlawful manufacture, sale, distribution, dispensation, possession, or use of a controlled substance or marijuana during the performance of the Contract.

Company Name

BY: Authorized Officer or Agent Date
(Service Provider Signature)

Title of Authorized Officer or Agent of Service Provider

Printed Name of Authorized Officer or Agent

End of Exhibit F.



EXHIBIT G
PURCHASING POLICY ADDENDUM

I, _____, hereby certify that I have received a copy of the City of Brookhaven, GA, Financial Management Policies Purchasing Policy which can be found at <http://brookhavenga.gov/city-departments/purchasing> and agree to comply with all requirements of the City of Brookhaven, GA Financial Management Policies Purchasing Policy to the extent the policy is applicable to the undersigned.

BY: Authorized Officer or Agent Date
(Service Provider Signature)

Title of Authorized Officer or Agent of Service Provider

Printed Name of Authorized Officer or Agent Date

End of Exhibit G.

EXHIBIT H
AFFIDAVIT VERIFYING STATUS FOR CITY PUBLIC BENEFIT APPLICATION

By executing this affidavit under oath, as an applicant for a City of Brookhaven, Georgia Business License or Occupation Tax Certificate, Alcohol License, Taxi Permit, execution of contract or other public benefit as referenced in O.C.G.A. § 50-36-1, I am stating the following with respect to my application for a City of Brookhaven license/permit and /or contract for

[Name of natural person applying on behalf of individual, business, corporation, partnership, or other private entity]:

1. _____ I am a United States citizen

OR

2. _____ I am a legal permanent resident 18 years of age or older or I am an otherwise qualified alien or non-immigrant under the Federal Immigration and Nationality Act 18 years of age or older and lawfully present in the United States. *

In making the above representation under oath, I understand that any person who knowingly and willfully makes a false, fictitious, or fraudulent statement or representation in an affidavit shall be guilty of a violation of O.C.G.A. § 16-10-20.

Signature of Applicant: _____

Date: _____

Printed Name: _____

* Alien Registration number for non-citizens: _____

**** PLEASE INCLUDE A COPY OF YOUR PERMANENT RESIDENT CARD, EMPLOYMENT AUTHORIZATION, GREEN CARD, PASSPORT WITH A COPY OF YOUR DRIVER LICENSE, OR OTHER DOCUMENTATION AS ALLOWED UNDER THE LAW IF YOU ARE A LEGAL PERMANENT RESIDENT (#2).**

Subscribed and Sworn Before Me, this the ____ day of _____, 20__’

Notary Public:

My Commission Expires: _____

* Note: O.C.G.A. § 50-36-1(e)(2) requires that aliens under the Federal Immigration and Nationality Act, Title 8 U.S.C., as amended, provide their alien registration number. Because legal permanent residents are included in the Federal definition of “alien”, legal permanent residents must also provide their alien registration number. Qualified aliens that do not have an alien registration number may supply another identifying number below:

EXHIBIT I
REFERENCES
ITB 20-101, CAPITAL PAVING PROJECT

Please provide as references, the names of at least three (3) local corporate clients you have served for at least three (3) years.

1. Company Name: _____
 Address: _____
 Contact: _____ Phone: _____

2. Company Name: _____
 Address: _____
 Contact: _____ Phone: _____

3. Company Name: _____
 Address: _____
 Contact: _____ Phone: _____

SUBCONTRACTORS
ITB 20-101, CAPITAL PAVING PROJECT

Please provide the names, address, contact name and phone number of all Subcontractors that will be utilized by the Contractor for the duration of any resulting award.

1. Company Name: _____

Address: _____

Contact: _____ Phone: _____

2. Company Name: _____

Address: _____

Contact: _____ Phone: _____

3. Company Name: _____

Address: _____

Contact: _____ Phone: _____

4. Company Name: _____

Address: _____

Contact: _____ Phone: _____

5. Company Name: _____

Address: _____

Contact: _____ Phone: _____

End of Exhibit I.

EXHIBIT J
NON-COLLUSION AFFIDAVIT
ITB 20-101, CAPITAL PAVING PROJECT

The undersigned bidder or agent, being duly sworn on oath, says that he/she has not, nor has any other member, representative, or agent of the firm, company, corporation or partnership represented by him, entered into any combination, collusion or agreement with any person relative to the price to be bid by anyone at such letting nor to prevent any person from bidding nor to include anyone to refrain from bidding, and that this bid is made without reference to any other bid and without any agreement, understanding or combination with any other person in reference to such bidding.

He/She further says that no person or persons, firms, or corporation has, have or will receive directly or indirectly, any rebate, fee gift, commission or thing of value on account of such sale.

OATH AND AFFIRMATION

I HEREBY AFFIRM UNDER THE PENALTIES FOR PERJURY THAT THE FACTS AND INFORMATION CONTAINED IN THE FOREGOING BID FOR PUBLIC WORKS ARE TRUE AND CORRECT.

Dated this _____ day of _____, _____

(Name of Organization)

(Title of Person Signing)

(Signature)

(Bid Number)

ACKNOWLEDGEMENT

STATE OF _____)

COUNTY OF _____)

Before me, a Notary Public, personally appeared the above named and swore that the statements contained in the foregoing document are true and correct.

Subscribed and sworn to me this _____ day of _____, _____.

Notary Public Signature

My Commission Expires: _____

EXHIBIT K**BID SCHEDULE
ITB 20-101, CAPITAL PAVING PROJECT**

| Item No. | Description | Units | Estimated Quantity | Unit Price | Total Price |
|-----------------|--|--------------|---------------------------|-------------------|--------------------|
| 150-1001 | Traffic Control | LS | 1 | | |
| 310-1101 | Graded Aggregate Base--including material | TN | 220 | | |
| 402-1802 | Recycled Asphalt Concrete Patching using 19 MM Superpave including Bituminous Material & H Lime | TN | 100 | | |
| 402-3103 | Recycled Asphalt Concrete 9.5 MM Superpave Type 2 GP 1 or Blend 1 including Bituminous Material and H-Lime | TN | 3600 | | |
| 413-1000 | Bitum Tack Coat | GL | 11,800 | | |
| 402-3190 | Recycled Asphalt Concrete 19 MM Superpave Type 1 GP 1 or Blend 1 including Bituminous Material and H-Lime | TN | 5860 | | |
| 432-5010 | Mill Asphaltic Concrete Pavement, Variable Depth | SY | 10,250 | | |
| 611-8050 | Adjust Manhole to Grade | EA | 45 | | |
| 611-8040 | Adjust Drop Inlet to Grade | EA | 1 | | |
| 611-8140 | Adjust Utility Valve to Grade | EA | 4 | | |
| 653-0120 | Thermoplastic Marking Arrow, Type 2 | EA | 1 | | |
| 653-1501 | Thermoplastic Solid Traffic Stripe, 5 in., White | LF | 1 | | |
| 437-0000 | Adjust Granite Curb, Tp A | LF | 16,600 | | |

EXHIBIT K**BID SCHEDULE
ITB 20-101, CAPITAL PAVING PROJECT**

| Item No. | Description | Units | Estimated Quantity | Unit Price | Total Price |
|-----------------|--|--------------|---------------------------|-------------------|--------------------|
| 653-1502 | Thermoplastic Solid Traffic Stripe, 5 in., Yellow | LF | 1 | | |
| 653-1704 | Thermoplastic Solid Traffic Stripe, 24 in., White | LF | 1 | | |
| 653-0210 | Thermoplastic Pvt Marking Word, Type 1 | EA | 1 | | |
| 653-1804 | Thermoplastic Solid Traffic Stripe, 8 in., White | LF | 1 | | |
| 441-0104 | Concrete sidewalk, 4 inches | SY | 50 | | |
| 457-1010 | Geogrid Reinforcement, Type B | SY | 50 | | |
| 441-0108 | Concrete sidewalk, 8 inches | SY | 55 | | |
| 215-0250 | Undercut Excavation | SY | 440 | | |
| 301-2160 | Soil Cement Stabilized Base Course 8 Inches | SY | 34,645 | | |
| 301-5000 | Portland Cement thoroughly mixed to a depth of 8 inches and compacted to at least 98 percent of standard Proctor maximum dry density | TN | 1190 | | |
| 211-0000 | Surge Stone | CY | 50 | | |
| | Remove and Reconstruct Speed Hump (includes striping | EA | 5 | | |

EXHIBIT K
BID SCHEDULE
ITB 20-101, CAPITAL PAVING PROJECT

Total Bid Excludes City Controlled Contingency

Total Base Bid Amount: _____

Total Base Bid Amount in Words: _____

Contractor: _____

Signature: _____

Print: _____

Date: _____

THIS PAGE MUST BE COMPLETED AND SUBMITTED AS A PART OF YOUR BID

Exhibit L

City of Brookhaven Diagrams

and

Public Works Department Special Provisions

**Modifications of the GDOT Standard Specifications, 2013
Edition**

DIAGRAM OF A CORRECTLY RAISED MANHOLE

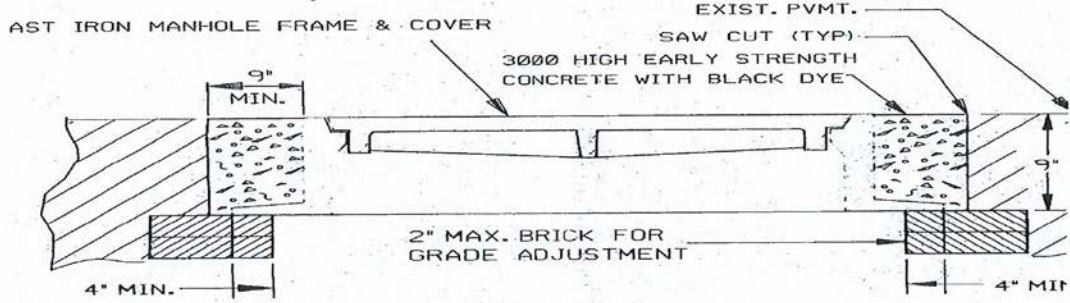

DRAWING 1

GENERAL NOTES :

1. SAW CUT TO BE IN ACCORDANCE WITH SECTION 444 OF STANDARD SPECIFICATION
2. A SURFACE TOLERANCE OF $\frac{1}{8}$ INCH IN TEN FEET AS DETERMINED BY STRAIGHTEDGE AND TRANSVERSE DIRECTIONS WILL NOT BE ACCEPTED FOR PAYMENT.
3. TRAFFIC WILL BE MAINTAINED AT ALL TIMES DURING CONSTRUCTION BY PERMITTED WARNING SIGNS, BARRICADES, AND LIGHTS NECESSARY TO CONTROL THE TRAFFIC AND DEVICES WILL BE IN ACCORDANCE WITH THE MANUAL ON UNIFORM TRAFFIC CONTROL

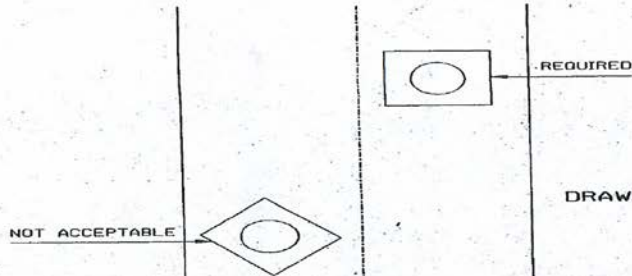

DRAWING 3

DIAGRAM OF A CORRECTLY RAISED VALVE

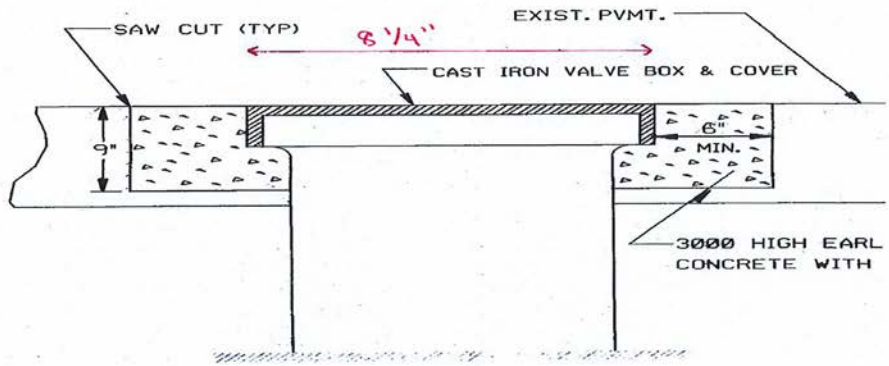

DRAWING 2

IT BE MEASURED FOR PAYMENT; COST TO BE INCLUDED IN PRICE BID FOR OTHER ITEMS. REQUIRED. WORK WITH IRREGULARITIES IN EXCESS OF 1/8 INCH IN TEN FEET IN LONGITUDINAL ONE OF TRAFFIC TO MOVE THROUGH THE CONSTRUCTION SITES. ALL FLAG PERSONS, PLATES, PUBLIC SHALL BE FURNISHED BY THE CONTRACTOR WITHOUT COST TO THE COUNTY. TRAFFIC CONTROLS AND HIGHWAYS.

| | | | | | | | |
|----------------------|--|--|--|---|--|-------|--|
| | | | | DEKALB COUNTY GOVERNMENT DEPARTMENT OF WATERSHED MANAGEMENT 1588 ROADWAY DRIVE - STONE MOUNTAIN, GA | | | |
| | | | | JOB TITLE | | LAND | |
| | | | | SHEET TITLE | | ACCOL | |
| | | | | DRAWN BY | | BOND/ | |
| | | | | CHECK BY | | SCALE | |
| | | | | APPROVED BY | | DATE | |
| NO. BY DATE REVISION | | | | | | SHEET | |

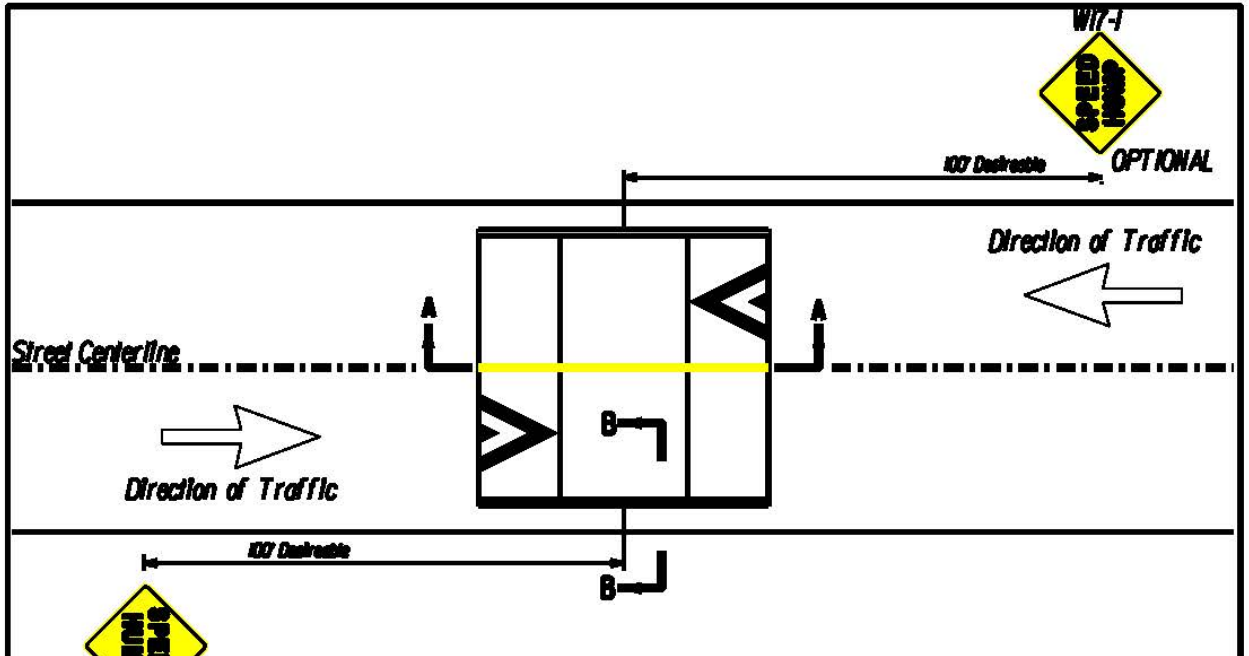

Plan View

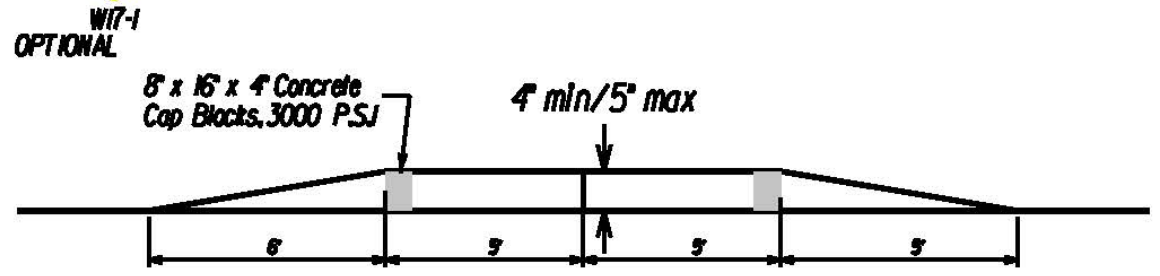

Section A - A

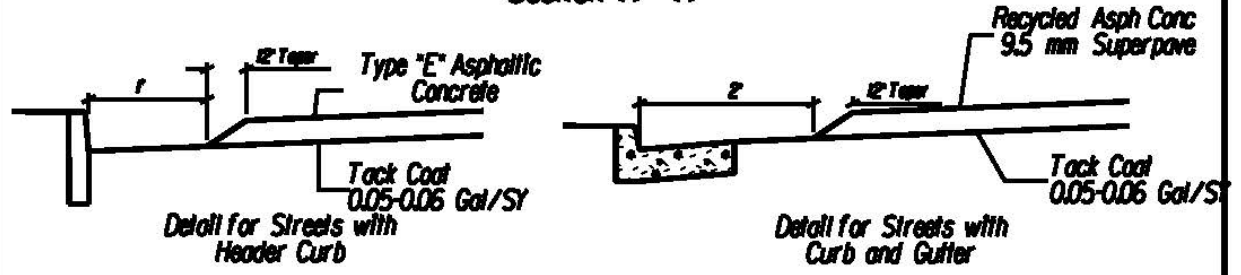

Section B - B

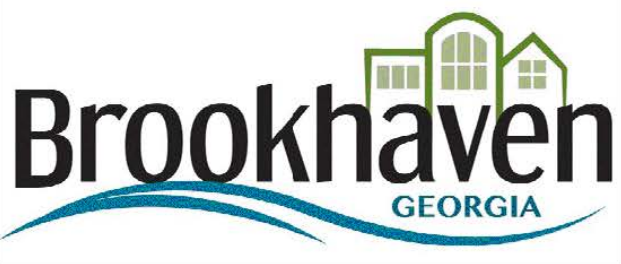

CITY OF BROOKHAVEN
PUBLIC WORKS DEPARTMENT

SPEED HUMP DETAIL

N.J.S

MAY 2015

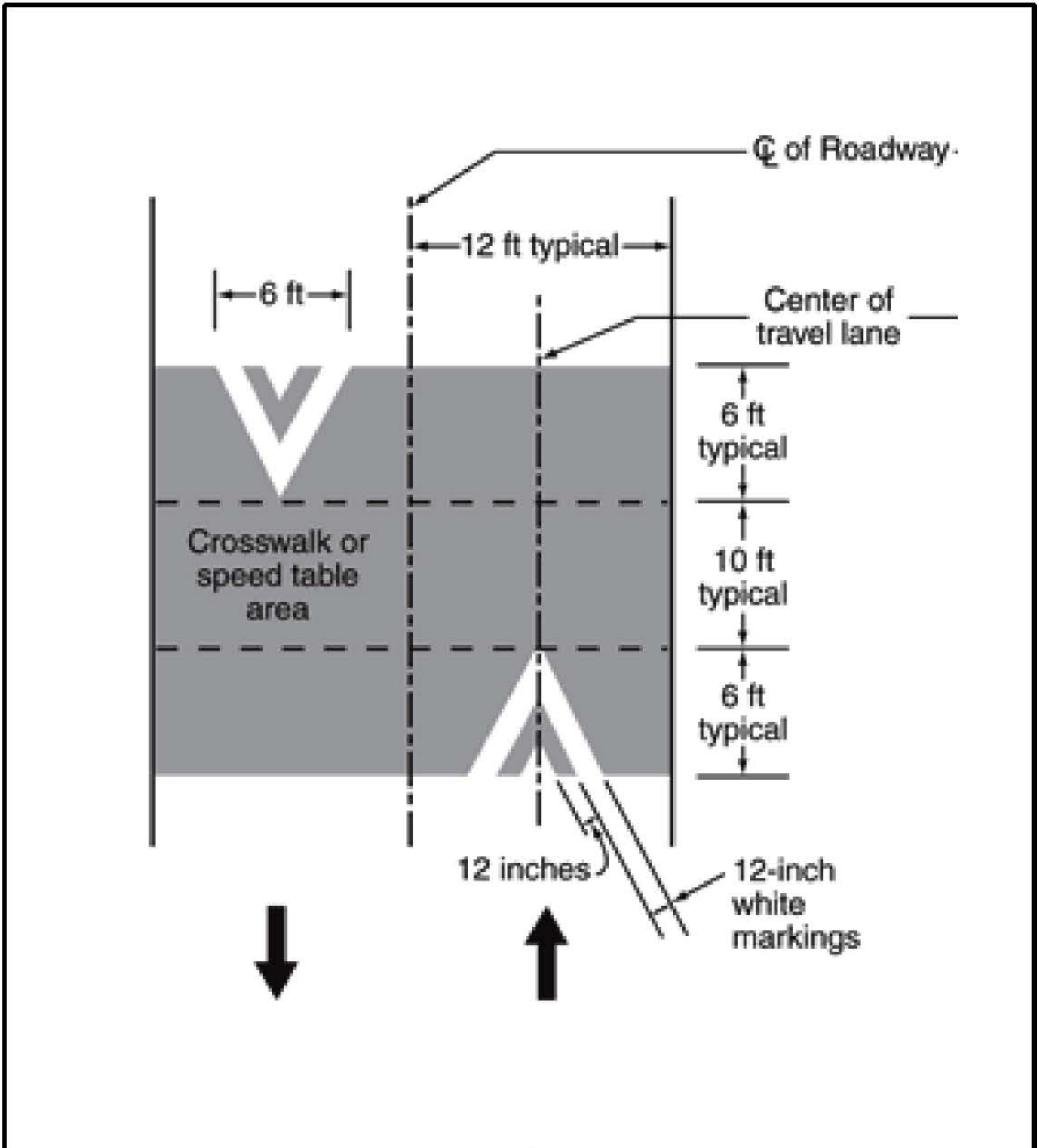

**CITY OF BROOKHAVEN
PUBLIC WORKS DEPARTMENT**

SPEED HUMP DETAIL

NJS

MAY 2015

**EXHIBIT L
TO CONTRACT AGREEMENT
SPECIAL PROVISIONS**

SECTION 107 – Legal Regulations and Responsibility to the Public

SECTION 108 – Prosecution and Progress

SECTION 150—Traffic Control

SECTION 161—Control of Soil Erosion and Sedimentation

CITY OF BROOKHAVEN
DEPARTMENT OF PUBLIC WORKS
SPECIAL PROVISION
PROJECT: 2019 Resurfacing & Reconstruction

Modifications of the GDOT Standard Specifications, 2013 Edition

SECTION 107 – Legal Regulations and Responsibility to the Public

Section 107.01 LAWS TO BE OBSERVED

Delete in its entirety and substitute the following:

The Contractor's attention is directed to the fact that all applicable Federal, State and County laws, municipal ordinances, and the rules and regulations of all authorities having jurisdiction over construction of the Projects shall apply to the Contract throughout, and they will be deemed to be included in the Contract as though written out in full herein. The Contractor shall keep fully informed of all laws, ordinances and regulations of the Federal, State, County, and municipal governments or authorities in any manner affecting those engaged or employed in the Work or the materials used in the Work or in any way affecting the conduct of the Work and of all orders and decrees of bodies or tribunals having any jurisdiction or authority over same. If any discrepancy or inconsistency should be discovered in these Contract Documents or in the Drawings or Specifications herein referred to, in relation to any such law, ordinance, regulation, order or decree, the Contractor shall herewith report the same in writing to the Owner. The Contractor shall at all times observe and comply with all such existing and future laws, ordinances and regulations, and shall protect and indemnify the Owner and the Owner's agents against the violation of any such law, ordinance, regulation, order or decree, whether by the Contractor or by the Contractor's employees.

Section 107.02 PERMITS AND LICENSES

Add the following:

Permits and licenses of a temporary nature, including building permits, necessary for the prosecution of the Work shall be secured and paid for by the Contractor. Permits, licenses and easements for permanent structures or permanent changes in existing facilities shall be secured and paid for by the Owner, unless otherwise specified. The Contractor will pay all sales, consumer, use and other similar taxes required by the law of the place where the Work is performed. The Contractor is obligated to comply with all local and state sales and use tax laws. The Contractor shall provide the Owner with documentation to assist the Owner in obtaining sales and/or use tax refunds for eligible machinery and equipment used for the primary purpose of reducing or eliminating air or water pollution as provided for in Chapter 48-8-3(36) and (37) of the Official Code of Georgia Annotated. Acceptance of the

project as completed will not be made by the Owner until the Contractor has fully complied with this requirement.

Section 107.07 PUBLIC CONVENIENCE AND SAFETY

Add the following:

The Contractor shall install all necessary appurtenances along highways, streets and roadways in accordance with MUTCD, Georgia DOT and City of Brookhaven regulations, with reference to construction operations, safety, traffic control, road maintenance and repair.

A. PROTECTION OF TRAFFIC:

The contractor shall provide suitable signs, barricades and lights for protection of traffic in locations where traffic may be endangered by Roadway improvements. They shall be removed as soon as conditions which necessitated their placement have been cleared. No highway, street, or roadway shall be closed without first obtaining permission from the proper authority.

1. The contractor shall provide, erect and maintain all necessary barricades suitable and sufficient lights and other traffic control devices; shall provide qualified flaggers where necessary to direct traffic; shall take all necessary precautions for the protection of the work and the safety of the public. Flaggers shall be certified by attending a Georgia DOT approved flagged training program.
2. Roadway construction traffic devices and their installation shall be in accordance with the current Manual On Uniform Traffic Control Devices for Streets and Highways.
3. Placement and removal of construction traffic control devices shall be coordinated with the City of Brookhaven a minimum of 48 hours in advance.
4. Installation of construction traffic control devices shall be performed prior to commencement of channel improvement activities. Construction traffic control devices shall be removed immediately following their useful purpose.
5. Traffic control devices used intermittently, such as Flagmen Ahead signs, shall be removed and replaced when needed.
6. Channelization devices shall be positioned preceding an obstruction at a taper length as required by current Manual on Uniform Traffic Control Devices for streets and Highways, appropriate for the speed limit at location. Channel devices shall be patrolled to ensure that they are maintained in the proper position throughout their period of use.

Section 107.13 PROTECTION AND RESTORATION OF PROPERTY AND LANDSCAPE

Section 107.13.B. EROSION AND SILTATION CONTROL

Add the following:

NOTE: The Contractor shall comply with all aspects of the National Pollutant Discharge Elimination System (NPDES) general Permit No. GAR 100002, current edition. All measures for the control of erosion and siltation must follow the guidelines as specified in the Georgia Erosion and Sedimentation Act of 1975 (as amended).

Add the following paragraphs to Section 107.13.C:

All measures required to minimize water pollution to affected waters shall be undertaken in the proposed Work. To achieve this end, regard shall be given to the protection of the watershed natural cover, measures instituted to assure minimal siltation and bank erosion from the construction, and other measures taken to reduce water pollution to a minimum. The Contractor must adhere to the Soil Erosion and Sedimentation Act of 1975 (as amended).

Any area used or involved in the Project disturbed by the Contractor, shall be restored to present or better condition even though such area is outside the limits of that specified for grading, grassing or landscaping.

All chemicals used during Project construction or furnished for Project operation, whether herbicide, pesticide, disinfectant, polymer, reactant or of other classification, must show approval of either EPA or USDA. Use of all such chemicals and disposal of residues shall be in strict conformance with instructions.

Necessary sanitary conveniences for the use of the labor on the Work shall be erected and maintained by the Contractor to comply with all applicable laws and regulations and in accordance with all Safety requirements. Their use shall be strictly enforced.

Should the Contractor so desire, he may build shanties or other structures for housing tools, machinery, and supplies, but they will be permitted only in locations approved by the Construction Manager, and their surroundings shall be maintained at all times in a sanitary and satisfactory manner. On or before the completion of the Work, all such structures shall be removed, together with all rubbish and trash, at the expense of the Contractor.

The Contractor shall restore all easement areas upon completion of the Work and before leaving the Project Work Area. The Owner reserves the right to withhold funds for unsatisfactory clean-up and easement restoration.

Section 107.16 OPENING SECTION OF PROJECT TO TRAFFIC

Add the following:

The Owner shall have the right to take possession of or use any completed or partially completed part of the Work. Prior to such possession or use, the Construction Manager shall furnish the Contractor an itemized list of work remaining to be performed or corrected on such portions of the Project as are to be possessed or used by the Owner, provided that failure to list any item of Work shall not relieve the Contractor of the responsibility for compliance with the terms of the Contract. Such possession or use

shall not be deemed an acceptance of any Work under the Contract. While the Owner has such possession or use, the Contractor, notwithstanding the provisions of the article of this Contract, entitled, Permits and Responsibilities shall be relieved of the responsibility for the loss or damage to the Work resulting from the Owner's possession or use. If such prior possession or use by the Owner delays the progress of the Work or causes additional expense to the Contractor, such shall be transmitted to the owner in writing and an equitable adjustment in the Contract Price or the time of completion may be made, and the Contract may be modified in writing accordingly.

Section 107.18 ACQUISITION OF RIGHT OF WAY

Add the following paragraphs:

The Owner will provide, as indicated in the Contract Documents, the lands upon which the Work is to be done, rights-of-way for access thereto, and such other lands which are designated for the use of the Contractor. The Contractor shall confine the Contractor's Work and all associated activities to the easements and other areas designated for the Contractor's use. The Contractor shall comply with any limits on construction methods and practices which may be required by easement agreements. If, due to some unforeseen reason, the necessary easements are not obtained as scheduled, the Contractor may receive an extension of Contract Time, dependent upon the effect on the critical path activities of the project schedule.

Notwithstanding any provision to the contrary herein, should the owner fail to obtain the necessary rights-of-way contemplated in the scope of work, and should the work to be performed be stopped, delayed and/or enjoined by a court-of-law or otherwise, either party may terminate this agreement pursuant to the Termination for Convenience Clause and such clause shall govern in all respects any termination stemming from the Owners failure to obtain the necessary rights-of-way contemplated in the scope of work.

The Contractor shall inspect all easements and rights-of-way to insure that the City has obtained all land and rights-of-way as shown in the plans necessary for completion of the Work to be performed pursuant to the Contract Documents. The Contractor shall comply with all stipulations contained in easements acquired by the City.

Section 107.20 NO WAIVER OF LEGAL RIGHTS

Add the words AND WARRANTY to the title of this section.

Add the following:

WARRANTY:

The Contractor shall warrant for a period of one year from the date of the final acceptance that the completed project is free from all defects due to faulty products or workmanship and the Contractor shall promptly make such corrections as may be necessary by reason of such defects. The Owner will give notice of observed defects with reasonable promptness. In the event that the Contractor should fail to make such repairs, adjustments, or other work that may be made necessary by such defects, the Owner may do so and charge the Contractor the cost thereby incurred. The Performance Bond shall

remain in full force and effect through the warranty period.

Section 107.21 CONTRACTORS RESPONSIBILITY FOR UTILITY PROPERTY AND SERVICE

Add the following sentence to 107.21.A:

The Contractor is responsible for the location of above and below ground utilities and structures which may be affected by the Work.

Add the following to 107.21.B:

EXISTING UNDERGROUND UTILITIES AND OBSTRUCTIONS:

The contractor, as required by Georgia Law (Code Section 25-9-1 through 25-9-13), shall call the Utilities Protection Center (UPC), and all utilities, agencies or departments that own/or operate utilities in the vicinity of the construction work site to verify the location of existing utilities.

A. EXISTING UTILITY LOCATION:

The following steps shall be exercised to avoid interruption of existing utility service.

- 1 Provide the required notice to the utility owners and allow them to locate their facilities according to the Georgia Law.
2. Expose the facility to verify its true location and grade in advance of roadway improvement. Repair or have repaired, any damage to utilities resulting from locating or exposing their true location.
3. Avoid utility damage and interruption by protecting it with means or methods recommended by the utility owner.

Add the following to 107.21.C.

The Contractor shall so schedule the Work that the operation of any existing facility, including water mains and sewers, will not be interrupted. In the event certain tie-ins or other operations make it absolutely necessary to interrupt the operation of existing facilities, the Owner will be notified and such work will be done at a time and in a manner acceptable to the Construction Manager. Bypasses of untreated or partially treated wastes which are absolutely necessary to complete the Work shall be shown on the Construction Progress Schedule. The Construction Manager shall be notified in writing of the date and time, and duration of such bypasses at least ten (10) days in advance.

The Contractor shall protect from damage all existing improvements or utilities at or in proximity to the site of the Work, and shall repair or restore any damage to such facilities resulting from failure to exercise reasonable care, in the performance of work. If the Contractor fails or refuses to repair any such damage promptly, the Owner may have the Work performed and charges the cost thereof to the Contractor.

Prior to implementing Roadway Improvements, the Contractor shall verify all existing utilities true vertical and horizontal location within the vicinity. In order to avoid conflicts between existing and proposed facilities or utilities, the Contractor shall take whatever means may be necessary to protect existing facilities or utilities during performance of Roadway Improvements, as approved by the Engineer/Construction Manager. No payment will be made for the relocation of existing utilities or for any work associated with the protection of existing facilities or utilities unless contract pay items are included.

The owner and/or operators of private or public utilities shall have access to such utilities at all times for the installation, maintenance, adjustment, repair and operation of said utilities. No extra compensation will be allowed because of the delay or interference caused by such work.

The plans show the approximate location of certain underground utilities, gas mains, water lines, drains, telephone cables, and structures according to information presented and available in the records. The determination of the exact location and other data on all existing facilities, their proper protection, maintenance and support during the prosecution of the work, is the express responsibility of the Contractor.

Wherever existing utilities are encountered which conflict in actual position and location with the proposed work, the Contractor shall promptly notify the utility owner and Construction Manager.

Temporary support, beams or bridging for utilities shall be left in place during backfill operations unless otherwise directed by the Construction Manager.

All costs in connection with supporting, protecting, relocating, removal, repair of damage, restoration of other ground structures, whether or not they are shown on the plans, not borne by the owner or owners of the utilities shall be borne by the Contractor.

No separate payment will be made for any work performed as herein above specified unless otherwise stated in the bid as a separate payment item. All costs in connection therewith shall be included in the contract price for the item to which the work pertains.

The Contractor shall be solely and directly responsible to the owner and/or other operator of such utility properties for any damage, injury, expense, loss, inconvenience or delay, or for any suits, actions, claims or any character brought on account of any damages which may result from the carrying out of the work.

The utilities shown on the plans are for the Contractor's benefit and are to be considered as approximate in location and are not all-inclusive or exact. It is the Contractor's responsibility to contact all utilities and have them locate their lines in the field. Utilities shall be contacted a minimum of three (3) working days prior to commencing of construction.

It will be the Contractor's responsibility to conform to all the requirements of the specifications as they relate to cooperation with utility owners and the protection of utility installations that exist on the Project.

The Contractor will not be paid for any delays or extra expense caused by utility facilities, obstructions, or any other items not being removed or relocated to clear construction in advance of his work.

It shall be the responsibility of the Contractor to coordinate his work with any work to be performed by others in any right-of-way clearance and arrange a schedule of operations that will allow for completion of the Project without undue delay.

Information concerning utility facilities known to exist within the Project limits is shown on the contract drawings.

Delete Subsection 107.23 and substitute the following:

107.23 Environmental Considerations

A. Construction

Erosion control measures shall be installed, to the greatest practical extent, prior to clearing and grubbing. Particular care shall be exercised along stream buffers, wetlands, open waters and other sensitive areas to ensure that these areas are not adversely affected.

Construction equipment shall not cross streams, rivers, or other waterways except at temporary stream crossing structures approved by the Engineer.

Construction activities within wetland areas are prohibited except for those within the construction limits as shown on the Plans and as specified in [Subsection 107.23.E](#).

All sediment control devices (except sediment basins) installed on a project shall, as a minimum, be cleaned of sediment when one half the capacity, by height, depth or volume, has been reached. Sediment basins shall be cleaned of sediment when one-third the capacity by volume has been reached.

B. Borrow and Excess Material Pits

Specific written environmental clearance from the Engineer will be required for any sites not included in the Plans as excess material or borrow areas. No work other than testing shall be started at any potential excess material or borrow site not shown on the plans prior to receiving said environmental clearance from the Engineer.

The Engineer will require a written notice from the Contractor requesting environmental clearance studies and written permission from the property owner at least six weeks prior to intended use of the site. The Department will not begin studies on such sites before a Notice to Proceed is issued.

The Engineer will inform the Contractor in writing as to the granting or denial of environmental clearance. If denied, the Contractor may, at no expense to the Department, seek to obtain permits or pursue other remedies that might otherwise render the site(s) acceptable.

Sites included in the Plans have environmental clearance and shall be used only for the purpose(s) specified in the Plans or other contract documents. Should the Contractor wish to expand or utilize said sites for any purpose other than that provided for in the Plans or other contract documents, specific written environmental clearance as noted above shall be obtained.

C. Control of Pollutants

Pollutants or potentially hazardous materials, such as fuels, lubricants, lead paint, chemicals or batteries, shall be transported, stored, and used in a manner to prevent leakage or spillage into the environment. The Contractor shall also be responsible for proper and legal disposal of all such materials.

Equipment, especially concrete or asphalt trucks, shall not be washed or cleaned-out on the Project except in areas where unused product contaminants can be prevented from entering waterways.

D. Temporary Work in Wetlands Outside of the Construction Limits within the Right-of-Way and Easement Areas

Temporary work in wetlands (that are not delineated with orange barrier fence) will be subject to the following requirements:

1. Temporary work in wetlands shall be accomplished by using temporary structures, timber, concrete, soil with geotextile fabric, or other suitable matting. The area shall not be grubbed.
2. Soil matting shall be protected from erosion in accordance with the Specifications.
3. Whenever temporary work is required in Saltwater Marsh Wetlands, all temporary structures and/or matting shall be removed in their entirety prior to Final Acceptance of the Project. Matted and compressed soils shall be backfilled to their original ground elevation with material meeting the requirements of [Section 212 – Granular Embankment](#).
4. Whenever temporary work is required in Freshwater Wetlands, all temporary structures and/or matting (exclusive of soil matting to be retained in the final roadway section) shall be removed in their entirety prior to Final Acceptance of the Project.

Once the temporary materials have been removed, the area shall be covered by Excelsior or Straw blankets according to [Section 713](#) of the Specifications. The grassing and ground preparation referenced in [Subsection 713.3.03, “Preparation”](#), will not be applicable to this Work.

5. The Engineer shall be notified so that a field inspection may be conducted to certify that the temporary materials were properly removed and that the area was properly restored. The Contractor shall be responsible for any corrective action required to complete this Work.
6. There will be no separate measurement or payment for this Work. The cost associated with this work shall be included in the overall Bid submitted.

E. Environmentally Sensitive Areas

Some archaeological sites, historic sites, wetlands, streams, stream and pond buffers, open waters and protected animal and plant species habitat within the existing/required Right-of-Way and easement areas may be designated as ENVIRONMENTALLY SENSITIVE AREAs (ESAs). These areas are shown on the applicable Plan sheets and labeled “ESA” (e.g. ESA – Historical Boundary, ESA – Wetland Boundary). The Department may require that some ESAs or portions

thereof be delineated with orange barrier fence. The Contractor shall install, maintain, and replace as necessary orange barrier fence at ESAs as delineated in the Plan sheets.

The Contractor shall not enter, disturb, or perform any construction related activities, other than those shown on the approved plan sheets within areas designated as ESAs including ESAs or portions thereof not delineated with orange barrier fence. This includes but is not limited to the following construction activities: clearing and grubbing; borrowing; wasting; grading; filling; staging/stockpiling; vehicular use and parking; sediment basin placement; trailer placement; and equipment cleaning and storage. Also, all archaeological sites, historic sites, wetlands, streams, stream and pond buffers, open waters, and protected animal and plant species habitat that extend beyond the limits of existing/required Right-of-Way and easement areas shall be considered ESAs and the Contractor shall not perform any construction related activities (such as those listed above) within these areas or make agreements with property owners to occupy these areas for construction related activities (such as those listed above). The Contractor shall make all construction employees aware of the location(s) of each ESA and the requirement to not enter or otherwise disturb these areas.

If the Contractor is found to have entered an ESA, either within or outside the project area, for any purpose not specifically shown on the approved plan sheets, the Department may, at its discretion, issue a stop work order for all activities on the project except erosion control and traffic control until such time as all equipment and other items are removed and the ESA is restored to its original condition.

However, should damage to an ESA occur as a result of the Contractor's action in violation of this section, and notwithstanding any subsequent correction by the Contractor, the Contractor shall be liable for any cost arising from such action, including but not limited to, the cost of repair, remediation of any fines, or mitigation fees assessed against the Department by another government entity.

Add the following Section 107.26 EQUAL OPPORTUNITY

Except as otherwise provided, during the performance of this Contract the Contractor agrees as follows:

The Contractor will not discriminate against any employee or applicant for employment because of race, color, religion, sex, or national origin.

The Contract will take affirmative action to ensure that applications are employed and treated during employment without regard to race, color, religion, sex, or national origin. Such action shall include but not be limited to, the following.

Employment, upgrading, demotion, or transfer; recruitment or recruitment advertising; layoff or termination; rates of pay or other forms of compensation; and selection for training, including apprenticeship.

The Contractor agrees to post in conspicuous places, available to employees and applicants for employment, notices setting forth the provisions of this Equal Opportunity Clause.

The Contractor will in all solicitations or advertisement for employees placed by or on behalf of the Contractor, state that all qualified applicants will receive consideration for employment without regard to race, color, religion, sex, or national origin.

The Contractor will send to each labor union or representative of workers with which Contractor has collective bargaining agreements or other contracts or understanding, a notice advising the labor union or worker's representative of the Contractor's commitments under this Equal Opportunity Clause, and shall post copies of the notice in conspicuous places available to employees and applicants for employment. Contractor agrees to comply with all Lawful agreements, if any, which the contractor had made with any association, union, or other entity, with respect to wages, salaries, and working conditions so as not to cause inconvenience, picketing, or work stoppage.

The Contractor shall include the provisions of this Equal Opportunity article in every subcontract or purchase order so that such provisions will be binding upon each subcontractor or vendor.

Failure of a successful bidder or contractor to fully disclose all the contractors or subcontractors to be engaged in a given public contract award may result in cancellation of the contract and imposition of a sanction on such violating bidder or contractor for the period of one (1) year.

CITY OF BROOKHAVEN
DEPARTMENT OF PUBLIC WORKS
SPECIAL PROVISION
PROJECT: 2019 Resurfacing & Reconstruction
Modifications of the GDOT Standard Specifications, 2013 Edition
Sec. 108 – Prosecution and Progress

In addition to the standard provisions Award and Execution of Contract shall include the following provisions and their cost:

Section 108—Prosecution and Progress

108.01 Subletting of Contract

The Contractor shall not sublet, sell, transfer, assign, or otherwise dispose of the Contract or Contracts, or any portion thereof, or of his/her right, title, or interest therein, without written consent of the Engineer. For Subcontracts, consent of the Engineer will not be considered until after award of the Contract.

In case such consent is given, the Contractor will be permitted to sublet a portion thereof, but shall perform, with his/her own organization, work amounting to not less than thirty percent (30%) of the total Contract cost, including materials, equipment, and labor.

As further exception, any items designated as Specialty Items may be performed by Subcontract and the cost of any such Specialty Items so performed by Subcontract may be deducted from the total cost before computing the amount of work required to be performed by the Contractor with his/her own organization.

Purchase of materials by the Prime Contractor for use by a Subcontractor will not be allowed when computing the 30% requirement.

No Subcontracts, or transfer of Contract, shall in any case release the Prime Contractor of his/her liability under the Contract and Bonds. No Subcontractor shall commence work in advance of the written approval of the Subcontract by the Department. Except for certain items exempted by the State Transportation Board, or for Subcontracts totaling \$250,000 or less, each Subcontractor shall be prequalified or registered with the Department. Each Subcontract for a Registered Subcontractor shall not exceed \$1,000,000 and Subcontracts for Prequalified Contractors shall not exceed their current capacity. Prequalified or Registered Subcontractors shall be qualified or registered with the Department in accordance with Chapter 672-5 of the Rules and Regulations Governing the Prequalification of Prospective Bidders adopted by the State Transportation Board.

In the event any portion of a Subcontract is further sublet, all of the provisions governing subletting, including registration and written approval by the Engineer, shall apply.

This Sub-Section shall not apply to Contracts between the City and counties, other municipalities, or State agencies.

All subcontract agreements between the Prime Contractor and subcontractor shall be in writing and shall contain all pertinent provisions of the Prime Contract. The Prime Contractor shall, upon request by the Engineer, furnish copies of any subcontract agreement to the Department within ten (10) days of such request. This provision applies to all subcontracts, including second or multi-tier subcontracts. According to the provisions stated above, the following items are designated Specialty Items for general transportation system construction and building construction whenever they appear in the Contract:

General Transportation System Contracts

- Grassing items
- Fencing items
- Highway lighting items
- Sign items
- Guardrail items (except bridge handrail)
- Utility items
- Comfort and convenience items in rest areas
- Landscaping items
- Pressure grouting, slab removal and replacement
- Permanent traffic markings
- Signal systems
- Railroad track work above sub-ballast
- Drilled caisson foundations
- Construction layout
- Asphaltic concrete leveling and asphalt concrete patching (when used on surface treatment and slurry seal resurfacing contracts)

The Contractor's cost for Construction Layout shall be fully documented prior to deduction from the original Contract amount). The Contractor shall provide a plan & cost breakout of the contract work to be performed with its own organization at the pre-construction meeting. In addition, the Contractor shall provide copies of subcontract agreements to the pre-construction meeting. The percentage of the contract work performed with its own organization shall be included on any pay application.

Delete the fifth paragraph from Subsection 108.01 and substitute the following:

No Subcontracts, or transfer of Contract, shall in any case release the Prime Contractor of his/her liability under the Contract and Bonds. No Subcontractor shall commence work in advance of the written approval of the Subcontract by the Department. Except for certain items exempted by the State Transportation Board, each Subcontractor shall be prequalified or registered with the Department. Each Subcontract for a Registered Subcontractor shall not exceed \$1,000,000.00 and

Subcontracts for Prequalified Contractors shall not exceed their current capacity. Prequalified or Registered Subcontractors shall be qualified or registered with the Department in accordance with Chapter 672-5 of the Rules and Regulations Governing the Prequalification of Prospective Bidders adopted by the State Transportation Board.

Delete Subsection 108.06 and substitute the following:

The engineer has the authority to suspend the Work wholly or in part, for as long as he may deem necessary, because of unsuitable weather, or other conditions considered unfavorable for continuing the Work, or for as long as he may deem necessary by reason of failure of the Contractor to carry out orders given, or to comply with any provisions of the Contract. If the performance of all or any portion of the Work is suspended or delayed by the Engineer, in writing, for an unreasonable period of time (not originally anticipated, customary, or inherent to the construction industry) and the Contractor believes that additional compensation and/or contract time is due as a result of such suspension or delay, the Contractor shall submit to the Engineer, in writing, a request for adjustment within 7 calendar days of receipt of the notice to resume work. The request shall set forth the reasons and support for such adjustment.

Upon receipt, the Engineer will evaluate the Contractor's request. If the Engineer agrees that the cost and/or time required for the performance of the Contract has increased as a result of such suspension and the suspension was caused by conditions beyond the control of, and not the fault of, the Contractor, its suppliers, or subcontractors at any approved tier, and not caused by weather, the Engineer will make an adjustment (excluding profit) and modify the Contract in writing accordingly. The Engineer will notify the Contractor of his/her determination whether or not an adjustment of the Contract is warranted.

No contract adjustment will be allowed unless the Contractor has submitted the request for adjustment within the time prescribed.

No contract adjustment will be allowed under this clause to the extent that performance would have been suspended or delayed by any other cause, or for which an adjustment is provided for or excluded under any other term or condition of this Contract.

108.08 Add the following to Subsection:

In order to minimize the disruption of normal traffic flow, separate completion times are specified for those portions of the work that require closing of lanes as specified in Subsection 150.11.

- C. Failure to reopen the lanes as specified in Special Provision 150.11 will result in the assessment of Liquidated Damages at the rate of \$500.00 per hour or portion of an hour thereof.
- D. The contractor shall have 90 days from notice to proceed to complete the project. Failure to complete the required construction as specified will result in the assessment of Liquidated Damages at the rate of \$1000 per Calendar Day.
- E. Failure to install speed humps within 7 calendar days as specified in General Note #16 will

result in the assessment of Liquidated Damages at the rate of \$100 per Calendar Day.

F. All Liquidated Damages specified above are cumulative and are in addition to those which may be assessed in accordance with Sub-section 108.08 for failure to complete the overall Project.

G. ITS System:

- a. Failure to adhere to outage restrictions for an individual ITS component as specified in Section 150.11 H will result in the assessment of Liquidated Damages at a rate of \$500.00 per hour or any part thereof for each individual ITS component after a 24 hour re-establishment period and value has been given by GDOT and the City of Brookhaven.

CITY OF BROOKHAVEN

DEPARTMENT OF PUBLIC WORKS

SPECIAL PROVISION

PROJECT: 2019 Resurfacing & Reconstruction

Modifications of the GDOT Standard Specifications, 2013 Edition

Section 150—Traffic Control

150.1 GENERAL

This section as supplemented by the Plans, Specifications, and Manual on Uniform Traffic Control Devices (MUTCD) shall be considered the Temporary Traffic Control (TTC) Plan. Activities shall consist of furnishing, installing, maintaining, and removing necessary traffic signs, pedestrian signs, barricades, lights, signals, cones, pavement markings and other traffic control devices and shall include flagging and other means for guidance and protection of vehicular and pedestrian traffic through the Work Zone. This Work shall include both maintaining existing devices and installing additional devices as necessary in construction work zones.

When any provisions of this Specification or the Plans do not meet the minimum requirements of the MUTCD, the MUTCD shall control. The 2009 Edition of the MUTCD shall be in effect for the duration of the project.

The needs and control of all road users (motorists, bicyclists and pedestrians within the highway right-of-way and easements, including persons with disabilities in accordance with the Americans with Disabilities Act of 1990 (ADA), Title II, Paragraph 35.130) through a Temporary Traffic Control (TTC) zone shall be an essential part of highway construction, utility work, maintenance operations and management of traffic incidents.

The Worksite Traffic Control Supervisor (WTCS) shall have a copy of Part VI of the MUTCD and the Contract on the job site. Copies of the current MUTCD may be obtained from the FHWA web page at <http://mutcd.fhwa.dot.gov>.

A. WORKER SAFETY APPAREL

All workers, including emergency responders, within the right-of-way who are exposed either to traffic (vehicles using the highway for purpose of travel) or to work vehicles and construction equipment within the TTC zone shall wear high-visibility safety apparel that meets the Performance Class 2 or 3 requirements of the ANSI/ISEA 107-2004 publication entitled "American National Standard for High-Visibility Safety Apparel and Headwear", or equivalent revisions, and labeled as meeting the ANSI 107-2004 standard performance for Class 2 or 3 risk exposure. Emergency and incident responders and law enforcement personnel within the TTC zone may wear high-visibility safety apparel that meets the performance requirements of the ANSI/ISEA 207-2006 publication entitled "American National Standard for High-Visibility Public Safety Vests", or equivalent revisions, and labeled as ANSI 207-2006, in lieu of ANSI/ISEA 107-2004 apparel. Firefighters or other emergency responders working within the right-of-way and engaged in emergency operations that directly expose them to flame, fire, heat, and/or hazardous material may wear retroreflective turn-out gear that is specified and regulated by other organizations, such as the National Fire Protection Association.

B. WORKSITE TRAFFIC CONTROL SUPERVISOR

ALL HIGHWAYS (ADDITIONAL REQUIREMENTS BELOW FOR INTERSTATES): The

Contractor shall designate a qualified individual as the Worksite Traffic Control Supervisor (WTCS) who shall be responsible for selecting, installing and maintaining all traffic control devices in accordance with the Plans, Specifications, Special Provisions and the MUTCD. A written resume documenting the experience and credentials of the WTCS shall be submitted and accepted by the Engineer prior to beginning any work that involves traffic control. The WTCS shall be available on a twenty-four (24) hour basis to perform his duties. If the work requires traffic control activities to be performed during the daylight and nighttime hours it may be necessary for the Contractor to designate an alternate WTCS. An alternate WTCS must meet the same requirements and qualifications as the primary WTCS and be accepted by the Engineer prior to beginning any traffic control duties. The Worksite Traffic Control Supervisor's traffic control responsibilities shall have priority over all other assigned duties.

As the representative of the Contractor, the WTCS shall have full authority to act on behalf of the Contractor in administering the TTC Plan. The WTCS shall have appropriate training in safe traffic control practices in accordance with Part VI of the MUTCD. In addition to the WTCS all other individuals making decisions regarding traffic control shall meet the training requirements of the Part VI of the MUTCD.

The WTCS shall supervise the initial installation of traffic control devices. The Engineer prior to the beginning of construction will review the initial installation. Modifications to traffic control devices as required by sequence of operations or staged construction shall be reviewed by the WTCS.

The WTCS shall be available on a full-time basis to maintain traffic control devices with access to all personnel, materials, and equipment necessary to respond effectively to an emergency situation within forty-five (45) minutes of notification of the emergency.

The WTCS shall regularly perform inspections to ensure that traffic control is maintained. Unless modified by the special conditions or by the Engineer, routine deficiencies shall be corrected within a twenty-four (24) hour period. Failure to comply with these provisions shall be grounds for dismissal from the duties of WTCS and/or removal of the WTCS from the project. Failure of the WTCS to execute his duties shall be considered as non-performance under [Subsection 150.08](#).

The Engineer will periodically review the work for compliance with the requirements of the TTC plan.

On projects where traffic control duties will not require full time supervision, the Engineer may allow the Contractor's Project Superintendent to serve as the WTCS as long as satisfactory results are obtained.

CERTIFIED WORKSITE TRAFFIC CONTROL SUPERVISOR

ADDITIONAL REQUIREMENTS FOR INTERSTATE AND LIMITED ACCESS HIGHWAYS: In addition to the requirements above, the WTCS shall have a minimum of one year's experience directly related to work site traffic control in a supervisory or responsible capacity. The WTCS shall be currently certified by the American Traffic Safety Services Association (ATSSA) Work Site Traffic Supervisor Certification program or the National Safety Council Certification program.

Any work performed on the interstate or limited access highway right-of-way that requires traffic control shall be supervised by the Certified Worksite Traffic Control Supervisor. No work requiring traffic control shall be performed unless the certified WTCS is on the worksite. Failure to maintain a Certified Worksite Traffic Control Supervisor on the work will be considered as non-performance under Subsection 150.08.

The WTCS shall perform, as a minimum, weekly traffic control inspections on all interstate and limited access highways. The inspection shall be reported to the Engineer on a TC-1 report. The Engineer will furnish a blank copy of the TC-1 report to the Contractor prior to the beginning of any work on the interstate or limited access right-of-way.

C. TRAFFIC CONTROL DEVICES

All traffic control devices used during the construction of a project shall meet the Standards utilized in the MUTCD, and shall comply with the requirements of these Specifications, Project Plans, and Special Provisions. All devices shall be tested at NCHRP Test Level III. Reference is made to [Subsections 104.05](#), [107.07](#), and [107.09](#).

D. REFLECTORIZATION REQUIREMENTS

All rigid fluorescent orange construction warning signs (black on fluorescent orange) shall meet the reflectorization and color requirements of ASTM Type VII, VIII, IX or X regardless of the mounting height.

Portable signs which have flexible sign blanks shall meet the reflectorization and color requirements of ASTM Type VI.

Warning signs (W3-1a) for stop conditions that have rumble strips located in the travelway shall be reflectorized with ASTM Type IX fluorescent yellow sheeting.

All other signs shall meet the requirements of ASTM Type III or IV except for "Pass With Care" and "Do Not Pass" signs which may be ASTM Type I unless otherwise specified.

CHANNELIZATION DEVICES: Channelization devices shall meet the requirements of ASTM Type III or IV high intensity sheeting.

E. IMPLEMENTATION REQUIREMENTS

No work shall be started on any project phase until the appropriate traffic control devices

have been placed in accordance with the Project requirements. Changes to traffic flow shall not commence unless all labor, materials, and equipment necessary to make the changes are available on the Project.

When any shift or change is made to the location of traffic or to the flow patterns of traffic, including pedestrian traffic, the permanent safety features shall be installed and fully operational before making the change. If staging or site conditions prevent the installation of permanent features then the equivalent interim devices shall be utilized. This work shall also include any necessary removal and reinstallation of guardrail panels to achieve the required panel lap to accommodate the appropriate shift and traffic flow including the final traffic flow configuration (The cost of performing this work shall be included in Traffic Control-Lump Sum).

Any section of the work that is on new location shall have all permanent safety features installed and fully operational before the work is opened to traffic. Safety features shall include but are not limited to the following items:

1. Guardrail including anchors and delineation with properly lapped panels
2. Impact attenuators
3. Traffic signals
4. Warning devices
5. Pavement markings including words, symbols, stop bars, and crosswalks
6. Roadway signs including regulatory, warning, and guide

Outdoor lighting shall be considered as a safety feature for welcome centers, rest areas, and weigh station projects. For typical roadway type projects new street lighting is not considered a safety feature unless specifically noted in the plans or in the special conditions.

F. MAINTENANCE OF TRAFFIC CONTROL DEVICES

Traffic control devices shall be in acceptable condition when first erected on the project and shall be maintained in accordance with [Subsection 104.05](#) throughout the construction period. All unacceptable traffic control devices shall be replaced within 24 hours. When not in use, all traffic control devices shall be removed, placed or covered so as not to be visible to traffic. All construction warning signs shall be removed within seven calendar days after time charges are stopped or pay items are complete. If traffic control devices are left in place for more than ten days after completion of the Work, the Department shall have the right to remove such devices, claim possession thereof, and deduct the cost of such removal from any monies due, or which may become due, the Contractor.

G. TRAFFIC INTERRUPTION RESTRICTIONS

The Department reserves the right to restrict construction operations when, in the opinion of the Engineer, the continuance of the Work would seriously hinder traffic flow, be needlessly disruptive or unnecessarily inconvenience the traveling public. The Contractor shall suspend and/or reschedule any work when the Engineer deems that conditions are unfavorable for continuing the Work.

Advanced notification requirements to the Contractor to suspend work will be according to the events and the time restrictions outlined below:

| | |
|---|-----------------------------|
| Incident management | No advanced notice required |
| Threatening/Inclement weather | 24 hours |
| Holidays, sporting events, unfavorable conditions | Three (3) calendar days |

If the work is suspended, the Contractor may submit a request for additional contract time as allowed under Section 108. The Department will review the request and may grant additional contract time as justified by the impact to the Contractor's schedule. Compensation for loss of productivity, rescheduling of crews, rental of equipment or delays to the Contractor's schedule will not be considered for payment. Additional contract time will be the only consideration granted to the Contractor.

H. SEQUENCE OF OPERATIONS

Any Sequence of Operations provided in this Contract in conjunction with any staging details which may be shown in the plans, is a suggested sequence for performing the Work. It is intended as a general staging plan for the orderly execution of the work while minimizing the impact on pedestrian facilities, mainline, cross-streets and side streets. The Contractor shall develop detailed staging and temporary traffic control plans for performing specific areas of the Work including but not limited to all traffic shifts, detours, bridge widenings, paces, or other activities that disrupt traffic or pedestrian flow. The Engineer may require detailed staging and TTC plans for lane closures or disruption to pedestrian facilities. These plans shall be submitted for approval at least two weeks prior to the scheduled date of the activity. Activities that have not been approved at least seven (7) days prior to the scheduled date shall be rescheduled.

Where traffic is permitted through the work area under stage construction, the Contractor may choose to construct, at no additional expense to the Department, temporary on-site bypasses or detours in order to expedite the work. Plans for such temporary bypasses or detours shall be submitted to the Engineer for review and approval 30 calendar days prior to the proposed construction. Such bypasses or detours shall be removed promptly when in the opinion of the Engineer; they are no longer necessary for the satisfactory progress of the Work. Bypasses and detours shall meet the minimum requirements of [Subsection 150.02.B.4.](#)

As an option to the Sequence of Operations in the Contract, the Contractor may submit an alternative Sequence of Operations for review and approval. Alternate Sequence of Operations for pedestrian facilities shall be in compliance with the MUTCD and ADA. Pedestrian needs identified in the preconstruction phase shall be included in the proposed alternate plan.

The Department will not pay, or in any way reimburse the Contractor for claims arising

from the Contractor's inability to perform the Work in accordance with the Sequence of Operations provided in the Contract or from an approved Contractor alternate.

The Contractor shall secure the Engineer's approval of the Contractor's proposed plan of operation, sequence of work and methods of providing for the safe passage of vehicular and pedestrian traffic before it is placed in operation. The proposed plan of operation shall supplement the approved traffic control plan. Any major changes to the approved TTC plan, proposed by the Contractor, shall be submitted to the Department for approval.

Some additional traffic control details will be required prior to any major shifts or changes in traffic. The traffic control details shall include, but not be limited to, the following:

1. A detailed drawing showing traffic locations and laneage for each step of the change.
2. The location, size, and message of all signs required by the MUTCD, Plan, Special Provisions, and other signs as required to fit conditions. Any portable changeable message signs used shall be included in the details.
3. The method to be used in, and the limits of, the obliteration of conflicting lines and markings.
4. Type, location, and extent of new lines and markings.
5. Horizontal and vertical alignment and superelevation rates for detours, including cross-section and profile grades along each edge of existing pavement.
6. Drainage details for temporary and permanent alignments.
7. Location, length, and/or spacing of channelization and protective devices (temporary barrier, guardrail, barricades, etc.)
8. Starting time, duration and date of planned change.
9. For each traffic shift, a paving plan, erection plan, or work site plan, as appropriate, detailing workforce, materials, and equipment necessary to accomplish the proposed work. This will be the minimum resource allocation required in order to start the work.

A minimum of three copies of the above details shall be submitted to the Engineer for approval at least 14 days prior to the anticipated traffic shift. The Contractor shall have traffic control details for a traffic shift which has been approved by the Engineer prior to commencement of the physical shift. All preparatory work relative to the traffic shift, which does not interfere with traffic, shall be accomplished prior to the designated starting time. The Engineer and the Contractor's representative will verify that all conditions have been

met prior to the Contractor obtaining materials for the actual traffic shift.

150.2 TEMPORARY TRAFFIC CONTROL (TTC) ZONES:

A. DEVICES AND MATERIALS:

In addition to the other provisions contained herein, work zone traffic control shall be accomplished using the following means and materials:

1. Portable Advance Warning Signs

Portable advance warning signs shall be utilized as per the requirements of the temporary traffic control plans. All signs shall meet the requirements of the MUTCD and shall be NCHRP 350 crashworthy compliant.

2. Arrow Panels

Portable sequential or flashing arrow panels as shown in the Plans or Specifications for use on Interstate or multi-lane highway lane closure only, shall be a minimum size of 48" high by 96" wide with not less than 15 lamps used for the arrow. The arrow shall occupy virtually the entire size of the arrow panel and shall have a minimum legibility distance of one mile. The minimum legibility distance is that distance at which the arrow panel can be comprehended by an observer on a sunny day, or clear night. Arrow panels shall be equipped with automatic dimming features for use during hours of darkness. The arrow panels shall also meet the requirements for a Type C panel as shown in the MUTCD. The sequential or flashing arrow panels shall not be used for lane closure on two-lane, two-way highways when traffic is restricted to one-lane operations in which case, appropriate signing, flaggers and when required, pilot vehicles will be deemed sufficient.

The sequential or flashing arrow panels shall be placed on the shoulder at or near the point where the lane closing transition begins. The panels shall be mounted on a vehicle, trailer, or other suitable support. Vehicle mounted panels shall be provided with remote controls. Minimum mounting height shall be seven feet above the roadway to the bottom of the panel, except on vehicle mounted panels which should be as high as practical.

For emergency situations, arrow display panels that meet the MUTCD requirements for Type A or Type B panels may be used until Type C panels can be located and placed at the site. The use of Type A and Type B panels shall be held to the minimum length of time possible before having the Type C panel(s) in operation. The Engineer shall determine when conditions and circumstances are considered to be emergencies. The Contractor shall notify the Engineer, in writing, when any non-specification arrow display panel(s) is being used in the work.

3. Portable Changeable Message Signs

Portable changeable message signs meeting the requirements of [Section 632](#) and the MUTCD. Any PCMS in use that is not protected by positive barrier protection shall be delineated by a minimum of three drums that meet the requirement of Section 150.05.A.1. The drum spacing shall not exceed a maximum of ten (10') feet as shown in

[Detail 150-PCMS](#). When the PCMS is within twenty (20') feet of the opposing traffic flow, the trailing end of the PCMS shall be delineated with a minimum of three drums spaced in the same manner as the approach side of the PCMS.

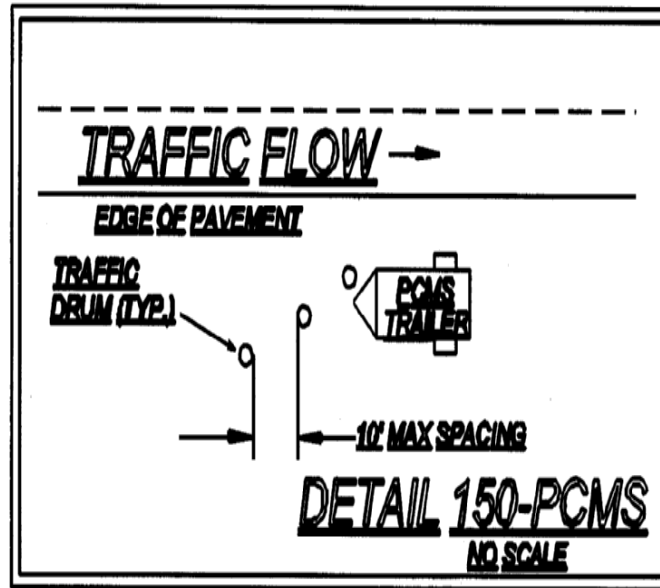

When not in use the PCMS shall be removed from the roadway unless protected by positive barrier protection. If the PCMS is protected by positive barrier protection the sign panel shall be turned away from traffic when not in use.

4. Channelization Devices
Channelization devices shall meet the standards of the MUTCD and [Subsection 150.05](#).
5. Temporary Barrier
Temporary barrier shall meet the requirements of [Section 622](#).
6. Temporary Traffic Signals
Temporary traffic signals shall meet the requirements of [Section 647](#) and the MUTCD.
7. Pavement Marking
Pavement marking incorporated into the work shall comply with [Subsections 150.04.A](#) and [150.04.B](#).
8. Portable Temporary Traffic Control Signals
The use of Portable Temporary Traffic Control Signals shall meet the following minimum requirements:

Only two-lane two-way roadways will be allowed to utilize Portable Temporary Traffic Control Signals.

All portable traffic control signals shall meet the physical display and operational requirements of conventional traffic signals described in the MUTCD.

Each signal face shall have at least three lenses. The lenses shall be red, yellow, or green in color and shall give a circular type of indication. All lenses shall be twelve (12") inches nominal in diameter.

A minimum of two signal faces shall face each direction of traffic. A minimum of one signal head shall be suspended over the roadway travel lane in a manner that will allow the bottom of the signal head housing to be not less than seventeen (17') feet above and not more than nineteen (19') feet above the pavement grade at the center of the travel lane. The second signal head may be located over the travel lane with the same height requirements or the second signal head may be located on the shoulder. When the signal head is located on the shoulder the bottom of the signal head housing shall be at least eight (8') feet but not more than (15') feet above the pavement grade at the center of highway.

Advance warning signage and appropriate pavement markings shall be installed as part of the temporary signal operation.

The signals shall be operated in a manner consistent with traffic requirements. The signals may be operated in timed-mode or in a vehicle-actuated mode. The signals shall be interconnected in a manner to ensure that conflicting movements cannot occur. To assure that the appropriate operating pattern including timing is displayed to the traveling public, regular inspections including the use of accurate timing devices shall be made by the Worksite Traffic Control Supervisor. If at any time any part of the system fails to operate within these requirements then the use of the signal shall be suspended and the appropriate flagging operation shall begin immediately.

The Worksite Traffic Control Supervisor (WTCS) shall continuously monitor the portable traffic control signal to insure compliance with the requirements for maintenance under the MUTCD. The signal shall be maintained in a manner consistent with the intention of the MUTCD, with emphasis on cleaning of the optical system. Timing changes shall be made only by the WTCS. The WTCS shall keep a written record of all timing changes.

The portable temporary signal shall have two power sources and shall be capable of running for seven calendar days continuously.

The Contractor shall have an alternate temporary traffic control plan in the event of failure of the signal.

9. RUMBLE STRIPS

Rumble strips incorporated into the work shall meet the requirements of [Section 429](#) and the MUTCD. Existing rumble strips that are positioned in the traveled way to warn traffic of a stop condition shall be reinstalled based on the following requirements:

INTERMEDIATE SURFACES: Intermediate surfaces that will be in use for more than forty-five (45) calendar days shall have rumble strips reinstalled on the traveled way in the area of a stop condition. Non-refundable deductions in accordance with [Subsection 150.08](#) will be assessed for any intermediate surface in place for greater than 45 days

without rumble strips.

FINAL SURFACES: Rumble strips shall be installed on the final surface within fourteen (14) calendar days of the placement of the final surface in the area of the stop condition. Failure to install within fourteen (14) calendar days will result in assessment of non-refundable deductions in accordance with Subsection 150.08.

Prior to the removal of any rumble strips located in the travelway, stop ahead (W3-1a) warning signs shall be double indicated ahead of the stop condition. These warning signs shall be a minimum of 48 inches by 48 inches. The reflectorization of the warning signs shall be as required by [Subsection 150.01.D](#). These warning signs shall remain in place until the rumble strips have been reinstalled on the traveled way. Any existing warning signs for the stop ahead condition shall be removed or covered while the 48" X 48" (W3-1a) signs are in place. When the rumble strips have been reinstalled these warning signs should be promptly removed and any existing signage placed back in service.

- 10. GUARDRAIL:** When the removal and installation of guardrail is required as a part of the work the following time restrictions shall apply unless modified by the special conditions:

MULTI-LANE HIGHWAYS: From the time that the existing guardrail or temporary positive barrier protection is removed the Contractor has fourteen (14) calendar days to install the new guardrail and anchors. During the interim, the location without guardrail shall be protected with drums spaced at a maximum spacing of twenty (20') feet. The maximum length of rail that can be removed at any time without being replaced with positive barrier protection is a total of 2000 linear feet of existing rail or the total length of one run of existing rail, whichever is less.

ALL OTHER HIGHWAYS: From the time that the existing guardrail is removed or from the time that temporary positive barrier protection is removed the Contractor has thirty (30) calendar days to install the new guardrail and anchors. During the interim, the location without guardrail shall be protected with drums spaced at a maximum spacing of twenty (20') feet. The maximum length of rail that can be removed at any time without being replaced with positive barrier protection is a total of 1000 linear feet of existing rail or the total length of one run of existing rail, whichever is less.

Based on existing field conditions, the Engineer may review the work and require that the guardrail be installed earlier than the maximum time allowed above by giving written notification to the Contractor via the TC-1 traffic control report.

ALL HIGHWAYS: The contractor shall install new guardrail such that traffic exposure to fixed objects is minimized. Within the same work day, temporary attenuators, as defined in [Subsection 150.05.B](#), should be installed on the approach to fixed objects that can't be protected with guardrail. Truck mounted attenuators may be used to shield exposed fixed objects for periods not to exceed forty-eight (48) hours. No separate payment will be made for truck mounted attenuators.

When the roadway is open to traffic, guardrail panels shall be lapped to comply with the directional flow of traffic. Should the staging of the work require that the lap of the guardrail be changed, this work shall be completed before the roadway is opened to traffic. The work to change the lap of any guardrail shall be included in Traffic Control-Lump Sum.

Failure to comply with the above time and quantity restrictions shall be considered as non-compliance under Subsection 150.08.

- 11. STOP SIGN REGULATED INTERSECTIONS:** For intersections that utilize stop sign(s) to control the flow of traffic and to restrict the movement of vehicles, the stop sign(s) shall be maintained for the duration of the work or until such time that the stop condition is eliminated or until an interim or permanent traffic signal can be installed to provide proper traffic control. The traffic signal shall be installed and properly functioning before the removal of the existing stop sign(s) is permitted. If the existing intersection is enhanced traffic control features such as stop bars, double indicated stop signs, oversized signs, advanced warning stop ahead signs, rumble strips on the approaches or flashing beacons located overhead or on the shoulders then these features shall be maintained for the duration of the project or until the permanent traffic control plan has been implemented.

Whenever the staging of the work requires that the traveled-way be relocated or realigned the Contractor shall reinstall all enhanced traffic control features noted above on the newly constructed sections of the work. The cost of relocating the stop bars, stop signs, advanced warning signs, the rumble strips and the flashing beacons shall be included in the price bid for Lump-Sum-Traffic Control unless individual pay items are included in the contract for rumble strips and/or flashing beacons. When pay items are included in the contract for rumble strips or flashing beacons then these items will be paid per each.

When staging requires the relocation or realignment of an existing stop condition it may be necessary to consider the addition of enhanced traffic control features even though none existed at the original location. Horizontal and vertical alignment changes at a new location may have decreased or restricted sight distance or the stop condition may occur sooner than in the previous alignment. If these conditions occur then the Engineer and/or the WTCS should consider additional measures to enhance the motorist's awareness of the changes even though the staging plans may not address enhanced features. Stop signs should be a minimum of 36 inches for interim situations. The use of 48 inch stop signs may be warranted under project specific conditions. Flags may be used on interim/permanent stop signs that are mounted at seven (7') feet in height for a short duration in order to direct additional attention to a new or relocated stop sign(s). Flags should not be used for durations exceeding two weeks unless unusual or site specific conditions warrant a longer period of time. The use of Type "A" flashing red light(s) attached to the stop sign(s) may be appropriate during the same period that the flags are in use to increase attention.

The use of rumble strips and/or portable changeable message signs may be considered.

The use of new rumble strips, where none previously existed, shall have the prior approval of District Traffic Operations before being included as part of the temporary traffic control plan. The message(s) displayed on any PCMS shall have the prior approval of the Engineer and the message(s) shall be included as part of the TTC plan for the interim staging.

The placement of any additional interim ground-mounted signs and posts or stop bars shall be considered as incidental to the price bid for Lump Sum-Traffic Control. The installation of rumble strips, flashing beacons or the use of Portable Changeable Message Signs (PCMS) shall be considered as Extra Work unless pay items are included in the contract.

B. WORK ZONE RESTRICTIONS:

1. Interstate

The Contractor shall not simultaneously perform work on both the inside shoulder and outside shoulder on either direction of traffic flow when the Work is within 12 feet of the travel-way, unless such areas are separated by at least one-half mile of distance.

2. Non-Interstate Divided Highways

The Contractor shall not simultaneously perform work on both the inside shoulder and outside shoulder on either direction of traffic flow when the Work is within 12 feet of the travel-way, unless such areas are separated by at least one-half mile distance in rural areas or at least 500 feet of distance in urban areas.

3. Non-Divided Highways

- a. The Contractor shall not simultaneously perform work on opposite sides of the roadway when the work is within 12 feet of the travel-way, unless such areas are separated by at least one-half mile of distance in rural areas or at least 500 feet of distance in urban areas.
- b. On two-lane projects where full width sections of the existing subgrade, base or surfacing are to be removed, and new base, subgrade, or surfacing are to be constructed, the Contractor shall maintain one-lane traffic through the construction area by removing and replacing the undesirable material for half the width of the existing roadway at a time. Replacement shall be made such that paving is completed to the level of the existing pavement in the adjacent lane by the end of the workday or before opening all the roadway to traffic.

4. All Highways:

- a. There shall be no reduction in the total number of available traffic lanes that existed prior to construction except as specifically allowed by the Contract and as approved by the Engineer.

- b. Travelway Clearances: All portions of the work shall maintain the following minimum requirements:

Horizontal: The combined dimensions of the paved shoulder and the roadway surface remaining outside the Work Zone shall be no less than sixteen (16) feet in width at any location.

Vertical: The overhead clearance shall not be reduced to less than fifteen (15) feet at any location.

The restrictions above apply to all shifts, lane closures, on-site detours and off site detours whether shown in the contract or proposed by the Contractor. It shall be the responsibility of the Contractor to verify that these minimum requirements have been met before proceeding with any phase of the Work Two-lane two-way roadways may have temporary horizontal restrictions of less than sixteen (16) feet provided a flagger operation for one-way traffic is utilized to restrict access to the work area by over-width loads. The minimum horizontal clearance shall be restored before the flagging operation is removed.

- c. Highway Work Zone: All sections or segments of the roadway under construction or reconstruction shall be signed as a Highway Work Zone except non-state highway two-lane two-way resurfacing projects. Two conditions can be applied to a Highway Work Zone. Condition 1 is when no reduction in the existing speed limit is required. Condition 2 is when worksite conditions require a reduction of the speed limit through the designated Work Zone. Properly marking a Highway Work Zone shall include the following minimum requirements:

1. NO REDUCTION IN THE EXISTING POSTED SPEED LIMIT IN HIGHWAY WORK ZONE:

- a) Signage ([Detail 150-HWZ-1](#)) shall be posted at the beginning point of the Highway Work Zone warning the traveling public that increased penalties for speeding violations are in effect. The [HWZ-2](#) sign shall be placed a minimum of six hundred (600') feet in advance of the Highway Work Zone and shall not be placed more than one thousand (1000') feet in advance of the Work Zone. If no speed reduction is required it is recommended that the [HWZ-2](#) be placed at 750 feet from the work area between the ROAD WORK 500 FT. and the ROAD WORK 1000 FT. signs.

[HWZ-2](#) signs shall be placed at intervals not to exceed one mile for the length of the project. [HWZ-2](#) signs should be placed on the mainline after all major intersections except State Routes. State Routes shall be signed as per the requirements for intersecting roadways below.

- b) The existing speed limit shall be posted at the beginning of the Work Zone. Existing Speed Limit signs (R2-1) shall be maintained.

- c) **INTERSECTING ROADWAYS:** Intersecting state routes shall be signed in advance of each intersection with the Work Zone with a [HWZ-2](#) sign to warn motorists that increased fines are in effect. All other intersecting roadways that enter into a designated Highway Work Zone may be signed in advance of each intersection with the Work Zone. When construction equipment and personnel are present in the intersection on the mainline of a multi-lane roadway, the intersecting side roads shall be signed in advance with [HWZ-2](#) signs. As soon as the work operation clears the intersection the signage may be removed.
- d) Sign [HWZ-3](#) shall be posted at the end of the Highway Work Zone indicating the end of the zone and indicating that increased penalties for speeding violations are no longer in effect.
- e) When a designated Highway Work Zone is no longer necessary all signs shall be removed immediately.

REDUCING THE SPEED LIMIT IN A HIGHWAY WORK ZONE:

Highway Work Zone signs shall be posted as required in Condition 1 above.

For limited access (interstate) highways and controlled access multi-lane divided highways the posted speed limit shall be reduced as required below.

Speed Limit signage (R2-1) for the reduced speed limit shall be erected at the beginning of the work zone. Additional signs shall be placed to ensure that the maximum spacing of the reduced speed limit signs shall be no greater than one (1) mile apart. Existing speed limit signs shall be covered or removed. On multi-lane divided highways the speed limit signs shall be double indicated when the reduced speed is in use.

When any one or more of the following conditions exist and the existing speed limit is 65 mph or 70 mph, the speed limit shall be reduced by 10 mph. If the existing speed limit is 60 mph, the speed limit should be reduced by 5 mph. If the existing speed limit is 55 mph or less, the Contractor can only reduce the speed limit with the prior approval of the Engineer. The reduction in the speed limit shall be no greater than 10 mph:

- a) Lane closure(s) of any type and any duration.
- b) The difference in elevation exceeds two inches adjacent to a travel lane as shown in [Subsection 150.06](#), [Detail 150-B](#), [Detail 150-C](#).
- c) Any areas where equipment or workers are within ten feet of a travel lane.
- d) Temporary portable concrete barriers located less than two (2') feet from the traveled way.
- e) As directed by the Engineer for conditions distinctive to this project.

When the above conditions are not present the speed limit shall be immediately

returned to the existing posted speed limit. A speed reduction shall not be put in place for the entire length of the project unless conditions warranting the speed reduction are present for the entire project length. All existing speed limit signs within the temporary speed reduction zone shall be covered or removed while the temporary reduction in the speed limit is in effect. All signs shall be erected to comply with the minimum requirements of the MUTCD.

As a minimum the following records shall be kept by the WTCS:

- a) Identify the need for the reduction.
- b) Record the time of the installation and removal of the temporary reduction.
- c) Fully describe the location and limits of the reduced speed zone.
- d) Document any accident that occurs during the time of the reduction.

A copy of the weekly records for reduced speed zones shall be submitted to the Engineer.

Reduced speed zones shall, as a minimum, be signed as per [Detail 150-HWZ-1](#). Interim signs shall meet the requirements of Subsection 150.03 D. Additional signs may be necessary to adjust for actual field conditions.

When a pilot vehicle is used on a two-lane two-way roadway the speed limit should not be reduced. For special conditions specific to the work, on two-lane two-way roadways or multi-lane highways, the contractor may reduce the posted speed limit with the prior approval of the Engineer.

5. MILLED SURFACE RESTRICTIONS:

Unless modified by the special conditions, a milled surface on any asphaltic concrete surface shall not be allowed to remain open to traffic for a period of time that exceeds thirty (30) calendar days.

6. INSTALLATION/REMOVAL OF WORK AREA SIGNAGE:

No payment will be made for Traffic Control-Lump Sum until the Work has actually started on the project. The installation of traffic control signage does not qualify as the start of work. Advanced warning signs shall not be installed until the actual beginning of work activities. Any permanent mount height signs installed as the work is preparing to start shall be covered until all signs are installed unless all signs are installed within seven (7) calendar days after beginning installation.

All temporary traffic control devices shall be removed as soon as practical when these devices are no longer needed. When work is suspended for short periods of time, temporary traffic control devices that are no longer appropriate shall be removed or covered.

All construction warning signs shall be removed within seven (7) calendar days after time charges are stopped or pay items are complete. If traffic control devices are left in place for more than ten (10) calendar days after completion of the Work, the Department shall have the right to remove such devices, claim possession thereof,

and deduct the cost of such removal from any monies due, or which may become due, the Contractor.

PUNCHLIST WORK: Portable signs shall be utilized to accomplish the completion of all punchlist items. The portable signs shall be removed daily. All permanent mount height signs shall be removed prior to the beginning of the punchlist work except “Low/Soft Shoulder” signs and any signs that have the prior written approval of the Engineer to remain in place while the punchlist work is in progress.

Failure to promptly remove the construction warning signs within the seven (7) calendar days after the completion of the Work or failure to remove or cover signs when work is suspended for short periods of time shall be considered as non-performance under Subsection 150.08.

SPEED LIMIT REDUCTION FOR HIGHWAY WORK ZONE
 INTERSTATE AND MULTI-LANE DIVIDED HIGHWAY SIGNING SHALL BE
 DOUBLE INDICATED (RIGHT SHOULDER AND MEDIAN SHOULDER)

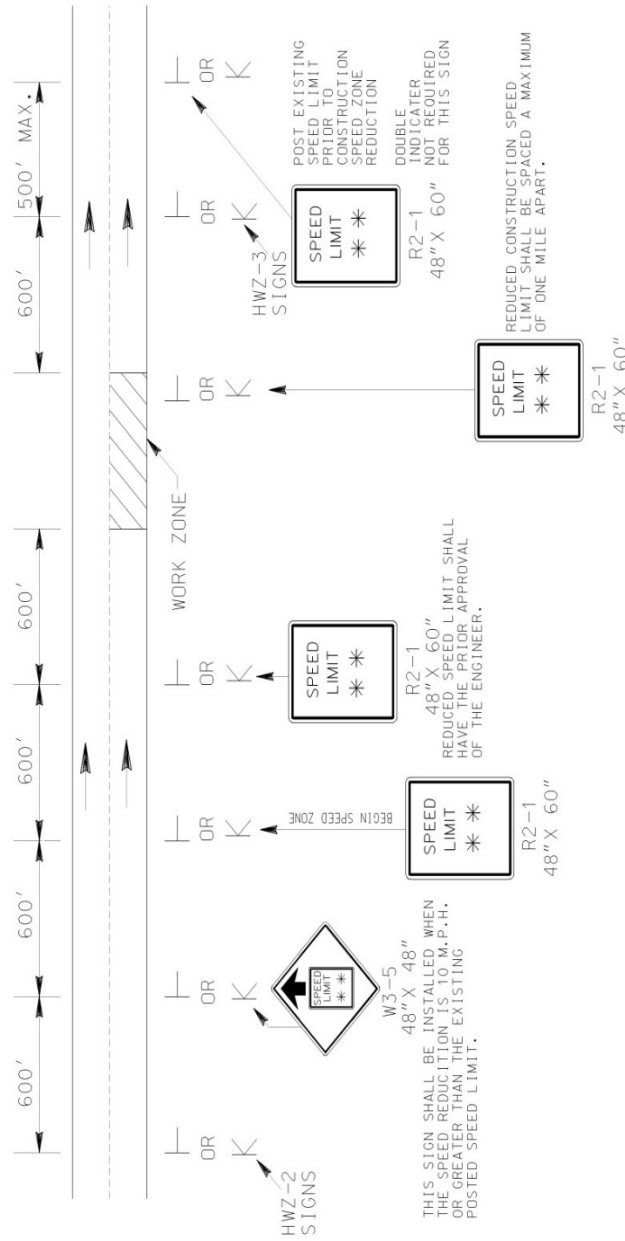

THIS SIGN SHALL BE INSTALLED WHEN THE SPEED REDUCTION IS 15 M.P.H. OR GREATER THAN THE EXISTING POSTED SPEED LIMIT.

ALL INTERSECTING ROADWAYS SHALL BE SIGNED WITH A HWZ-2 SIGN TO WARN MOTORIST ENTERING THE HIGHWAY WORK ZONE.

INTERSTATE AND MULTI-LANE HIGHWAY SIGNING SHALL BE DOUBLE INDICATED (RIGHT SHOULDER AND MEDIAN SHOULDER).

DETAIL 150-HWZ-1

POST EXISTING SPEED LIMIT PRIOR TO CONSTRUCTION SPEED ZONE REDUCTION

DOUBLE INDICATOR NOT REQUIRED FOR THIS SIGN

REDUCED CONSTRUCTION SPEED LIMIT SHALL BE SPACED A MAXIMUM OF ONE MILE APART.

REDUCED SPEED LIMIT SHALL HAVE THE PRIOR APPROVAL OF THE ENGINEER.

ALL INTERSECTING ROADWAYS SHALL BE SIGNED WITH A HWZ-2 SIGN TO WARN MOTORIST ENTERING THE HIGHWAY WORK ZONE.

INTERSTATE AND MULTI-LANE HIGHWAY SIGNING SHALL BE DOUBLE INDICATED (RIGHT SHOULDER AND MEDIAN SHOULDER).

THIS SIGN SHALL BE INSTALLED WHEN THE SPEED REDUCTION IS 15 M.P.H. OR GREATER THAN THE EXISTING POSTED SPEED LIMIT.

DETAIL 150-HWZ-1

SIGN SIZES SHOWN ARE FOR INTERSTATE AND MULTI-LANE DIVIDED HIGHWAY SIGNING. FOR OTHER HIGHWAY SIGNING, STANDARD SIZE SIGNS AS PER THE M.U.T.C.D. EXCEPT HWZ-2 AND HWZ-3 SIGNS.

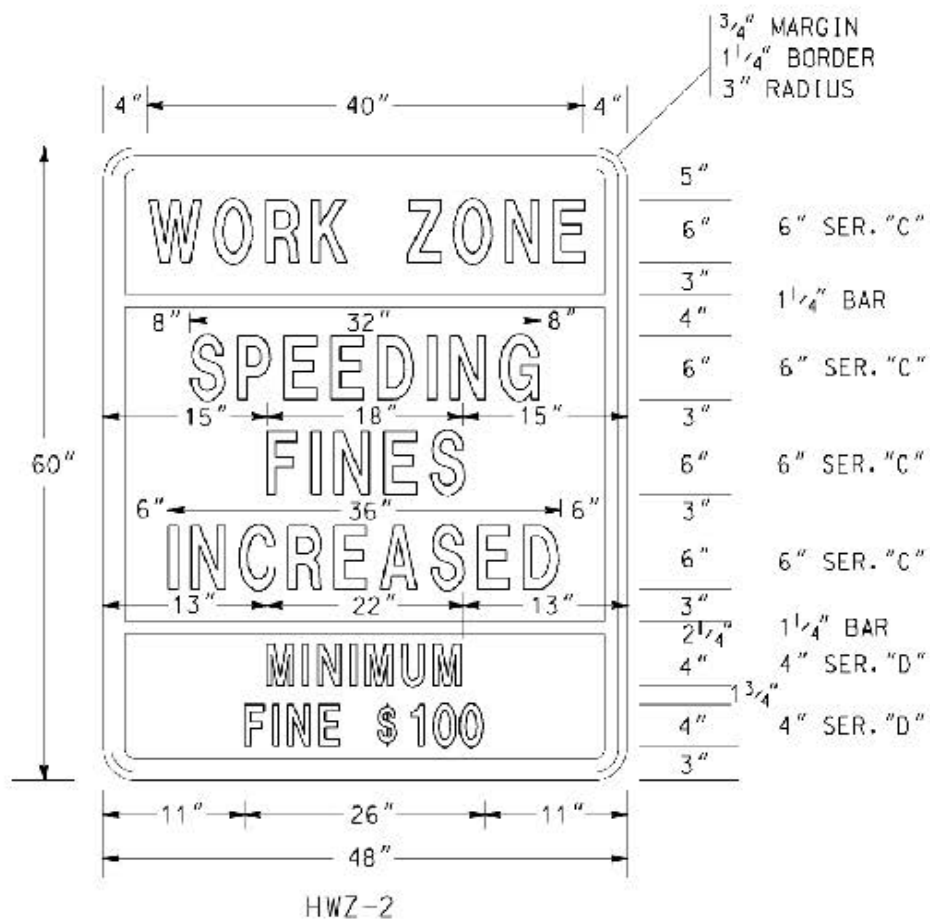

COLORS

TOP PANEL

LEGEND & BORDER - BLACK (NON-REFL)

BACKGROUND - FLUORESENT ORANGE

(ASTM TYPE VII, VIII, IX or X)

MIDDLE & BOTTOM PANELS

LEGEND & BORDER - BLACK (NON-REFL)

BACKGROUND - WHITE (ASTM TYPE III OR IV REFL SHEETING)

NOTES:

1. ALL HWZ-2 SIGN PANELS SHALL BE RIGID.
2. THE SIZE OF THE HWZ-2 SIGN SHALL NOT BE REDUCED FOR USE ON TWO-LANE ROADWAYS.

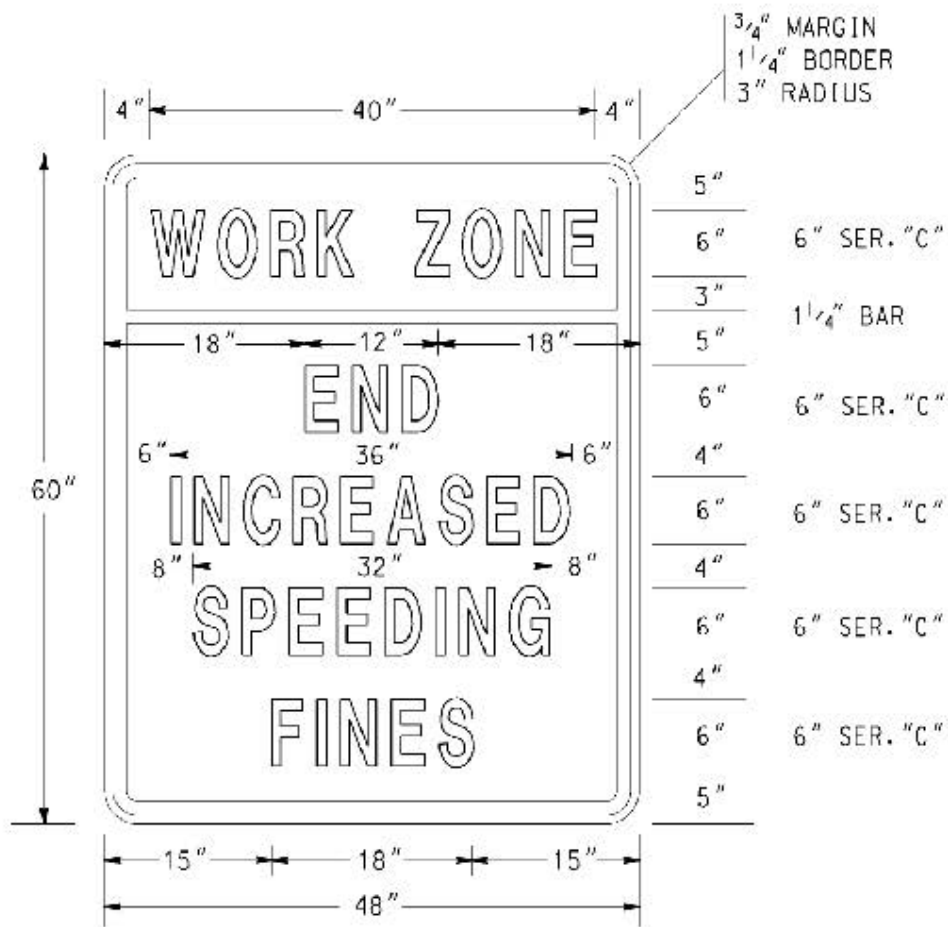

HWZ-3

COLORS

TOP PANEL

LEGEND & BORDER - BLACK (NON-REFL)

BACKGROUND - FLUORESENT ORANGE

(ASTM TYPE VII, VIII, IX or X)

BOTTOM PANEL

LEGEND & BORDER - BLACK (NON-REFL)

BACKGROUND - WHITE (ASTM TYPE III OR IV REFL SHEETING)

NOTES:

1. ALL HWZ-3 SIGN PANELS SHALL BE RIGID.
2. THE SIZE OF THE HWZ-3 SIGN SHALL NOT BE REDUCED FOR USE ON TWO-LANE ROADWAYS.

C. LANE CLOSURES:

1. **Approval/Restrictions**

All lane closures of any type or duration shall have the prior approval of the Engineer.

- a. The length of a lane closure shall not exceed two (2) miles in length excluding the length of the tapers unless the prior approval of the Engineer has been obtained. The Engineer may extend the length of a lane closure based upon field conditions however the length of a work zone should be held to the minimum length required to accomplish the Work. Lane closures shall not be spaced closer than one mile. The advanced warning signs for the project should not overlap with the advanced warning signs for lane shifts, lane closures, etc.
- b. Lane closures that require same direction traffic to be split around the Work Area will not be approved for roadways with posted speeds of 35 mph or greater, excluding turn lanes.
- c. For Interstate, Limited Access and Multi-lane Divided Highways, a Portable Changeable Message Sign (PCMS) shall be placed one (1) mile in advance of a lane closure with a message denoting the appropriate lane closure one mile ahead. The Portable Changeable Message Sign (PCMS) shall be placed on the outside shoulder in accordance with Detail 150-PCMS. This is in addition to the other traffic control devices required by Standard 9106.

2. **Removal Of Lane Closures**

To provide the greatest possible convenience to the public in accordance with Sub- [Subsection 107.07](#), the Contractor shall remove all signs, lane closure markings, and devices immediately when lane closure work is completed or temporarily suspended for any length of time or as directed by the Engineer. All portable signs and portable sign mounting devices shall be removed from the roadway to an area which will not allow the sign to be visible and will not allow the sign or sign mounting device to be impacted by traffic.

3. **Exit And Entrance Ramps**

On multilane highways where traffic has been shifted to the inside lanes, the exit and entrance ramps shall have channelization devices placed on both sides of the ramp. This requirement will apply to any situation where traffic is shifted to contra flows or inside staging lanes to facilitate reconstruction work in the vicinity of exit and entrance ramps. The temporary ramp taper length

shall be greater than, or equal to, the existing taper length. Interim EXIT gore signs shall be placed at the ramp divergence. The "EXIT OPEN" sign shown in Figure TA-42 of the MUTCD shall be utilized. For exit ramps, channelization device spacing shall be decreased to 10 feet for 200 feet in advance of the temporary gore, and be decreased to 10 feet for the first 100 feet of the temporary gore.

4. Lane Drop/Lane Closure

The first seven (7) calendar days of any lane closure shall be signed and marked as per Standard 9106 or 9107. However, lane closures that exist for a duration longer than seven (7) calendar days may be signed and marked as per the details in Standard 9121, provided the prior approval of the Engineer is obtained. The approved lane drop shall utilize only the signs and markings shown for the termination end of the lane drop in Standard 9121. All warning signs in the lane drop sequence shall be used. Drums may be substituted for the Type I Crystal Delineators at the same spacing.

5. Termination Area

The transition to normal or full width highway at the end of a lane closure shall be a maximum of 150 feet.

D. TRAFFIC PACING METHOD:

1. Pacing Of Traffic

With prior approval from the Engineer, traffic may be paced allowing the Contractor up to ten (10) minutes maximum to work in or above all lanes of traffic for the following purposes:

- a. Placing bridge members or other bridge work.
- b. Placing overhead sign structures.
- c. Other work items requiring interruption of traffic.

The Contractor shall provide a uniformed police officer with patrol vehicle and blue flashing light for each direction of pacing. The police officer, Engineer, and flaggers at ramps shall be provided with a radio which will provide continuous contact with the Contractor.

When ready to start the work activity, the police vehicle will act as a pilot vehicle slowing the traffic thereby providing a gap in traffic allowing the Contractor to perform the Work. Any on-ramps between the pace and the work area shall be blocked during pacing of traffic, with a flagger properly dressed and equipped with a Stop/Slow paddle. Each ramp should be opened

after the police vehicle has passed.

Pilot vehicles shall travel at a safe pace speed, desirably not less than 20 mph interstate and 10 mph non-interstate. The Contractor shall provide a vehicle to proceed in front of the police vehicle and behind the other traffic in order to inform the Contractor's work force when all vehicles have cleared the area.

Traffic will not be permitted to stop during pacing except in extreme cases as approved by the Engineer.

2. Methods Of Signing For Traffic Pacing

At a point not less than 1,000 feet in advance of the beginning point of the pace, the Contractor shall erect and cover a W-special sign (72 inch x 72 inch) with a Type "B" flashing light, with the legend "TRAFFIC SLOWED AHEAD SHORT DELAY" (See [Detail 150-A](#)). A portable changeable message sign may be used in lieu of the W-special sign. On divided highways this sign shall be double indicated. A worker with a two-way radio shall be posted at the sign, and upon notice that the traffic is to be paced shall turn on the flashing light and reveal the sign. When traffic is not being paced, the flashing light shall be turned off and the sign covered or removed. W-special signs are reflectorized black on orange, Series "C" letter and border of the size specified.

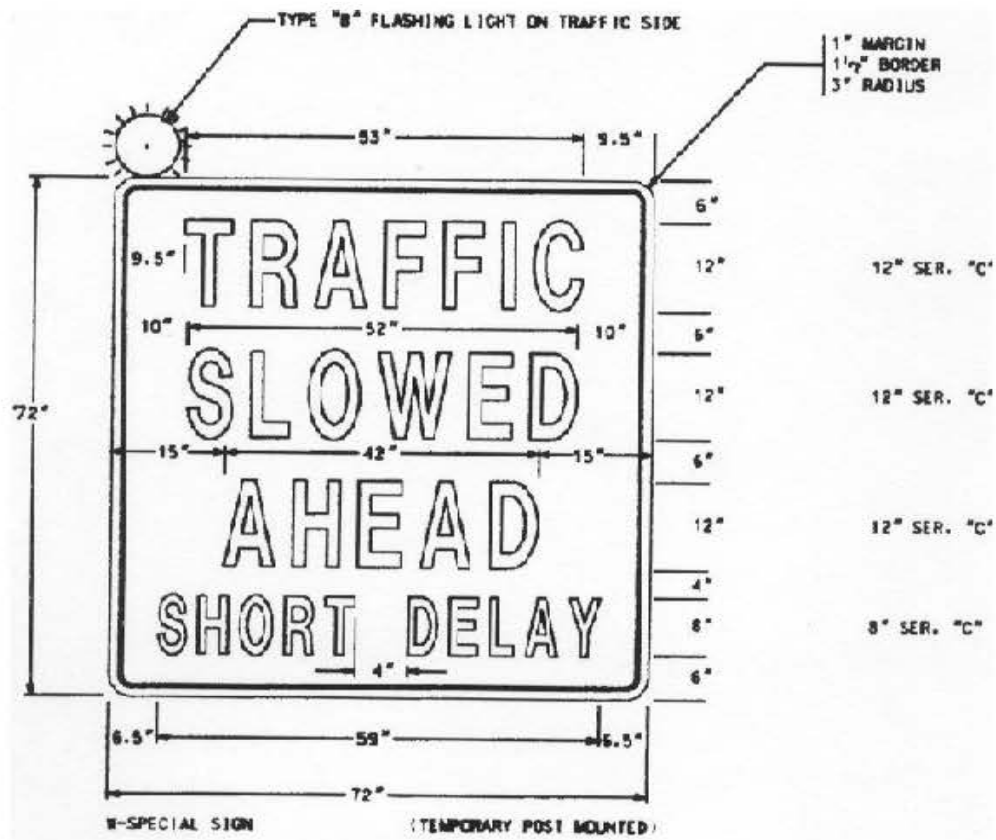

SIGN SHALL HAVE BLACK LEGEND AND BORDER
ON ORANGE REFLECTORIZED BACKGROUND

DETAIL 150-A

E. CONSTRUCTION VEHICLE TRAFFIC

The Contractor's vehicles shall travel in the direction of normal roadway traffic and shall not reverse direction except at intersections, interchanges, or approved temporary crossings. The Contractor may submit a plan requesting that construction traffic be allowed to travel in the opposite direction of normal traffic when it would be desirable to modify traffic patterns to accommodate specific construction activities.

Prior approval of the Engineer shall be obtained before any construction traffic is allowed to travel in a reverse direction. If the Contractor's submittal is approved the construction traffic shall be separated from normal traffic by appropriate traffic control devices.

F. ENVIRONMENTAL IMPACTS TO THE TEMPORARY TRAFFIC CONTROL (TTC) PLAN

The Contractor shall ensure that dust, mud, and other debris from construction activities do not interfere with normal traffic operations or adjacent properties. All outfall ditches, special ditches, critical storm drain structures, erosion control structures, retention basins, etc. shall be constructed, where possible, prior to the beginning of grading operations so that the best possible drainage and erosion control will be in effect during the grading operations, thereby keeping the roadway areas as dry as possible.

Areas within the limits of the project which are determined by the Engineer to be disturbed or damaged due either directly or indirectly from the progress or the lack of progress of the work shall be cleaned up, redressed, and regraded. All surplus materials shall be removed and disposed of as required. Surplus materials shall be disposed of in accordance with [Section 201](#) of the Specifications.

G. EXISTING STREET LIGHTS

Existing street lighting shall remain lighted as long as practical and until removal is approved by the Engineer.

H. NIGHTWORK

Adequate temporary lighting shall be provided at all nighttime work sites where workers will be immediately adjacent to traffic.

I. CONSTRUCTION VEHICLES IN THE WORKZONE

The parking of Contractor's and/or workers personal vehicles within the work area or adjacent to traffic is prohibited. It shall be the responsibility of the Worksite Traffic Control Supervisor to ensure that any vehicle present at the worksite is necessary for the completion of the work.

J. ENCROACHMENTS ON THE TRAVELED-WAY

The Worksite Traffic Control Supervisor (WTCS) shall monitor the work to ensure that all the rocks, boulders, construction debris, stockpiled materials, equipment, tools and other potential hazards are kept clear of the travelway. These items shall be stored in a location, in so far as practical, where they will not be subject to a vehicle running off the road and striking them.

K. PEDESTRIAN CONSIDERATIONS

All existing pedestrian facilities, including access to transit stops, shall be maintained. Where pedestrian routes are closed, alternate routes shall be provided. Closures of existing, interim and final pedestrian facilities shall have the prior written approval of the Engineer. When existing pedestrian facilities are disrupted, closed or relocated in a TTC zone, the temporary facilities shall be detectable and shall include accessibility features consistent with the features present in the existing pedestrian facility. Pedestrian facilities are considered improvements and provisions made to accommodate or encourage walking. Whenever a sidewalk is to be closed, the Engineer shall notify the maintaining agency two (2) weeks prior to the closure. Prior to closure, detectable barriers (that are detectable by a person with a visual disability traveling with the aid of a long cane), as described by the MUTCD, shall be placed across the full width of the closed sidewalk. Barriers and channelizing devices used along a temporary pedestrian route shall be in compliance with the MUTCD.

Temporary Traffic Control devices used to delineate a Temporary Traffic Control zone pedestrian walkway shall be in compliance with [Subsection 150.01.E](#). Temporary Traffic Control devices and construction material shall not intrude into the usable width of the pedestrian walkway. Signs and other devices shall be placed such that they do not narrow or restrict any pedestrian passage to less than 48 inches.

A pedestrian walkway shall not be severed or relocated for non-construction activities such as parking for construction vehicles and equipment. Movement by construction vehicles and equipment across designated pedestrian walkways should be minimized. When necessary, construction activities shall be controlled by flaggers. Pedestrian walkways shall be kept free of mud, loose gravel or other debris.

When temporary covered walkways are used, they shall be lighted during nighttime hours. When temporary traffic barrier is used to separate pedestrian and vehicular traffic, the temporary barrier shall meet NCHRP-350 Test Level Three. The barrier ends shall be protected in accordance with Georgia Standard 4960. Curbing shall not be used as a substitute for temporary traffic barriers when temporary traffic barriers are required. Tape, rope or plastic chain strung between temporary traffic control devices are not considered as detectable and shall not be used as a control for pedestrian movements.

The WTCS shall inspect the activity area daily to ensure that effective pedestrian TTC is being maintained. The inspection of TTC for pedestrian traffic shall be included as part of the TC-1 report.

1. Temporary Pedestrian Facilities

Temporary pedestrian facilities shall be detectable and include accessibility features consistent with the features present in the existing pedestrian facility. The geometry, alignment and construction of the facility should meet the applicable requirements of the "Americans with Disabilities Act Accessibility Guidelines for Buildings and Facilities (ADAAG)".

a. Temporary Walkways with Detectable Edging

A smooth, continuous hard surface (firm, stable and slip resistant) shall be provided throughout the entire length of the temporary pedestrian facility. Compacted soils, sand, crushed stone or asphaltic pavement millings shall not be used as a surface course for walkways.

Temporary walkways shall include detectable edging as defined in the MUTCD. When temporary traffic barrier is included as a pay item in the contract and where locations identified on the plans for positive protection will also allow them to serve as pedestrian detectable edging, payment will be made for the temporary traffic barrier in accordance with [Section 622](#). No payment will be made for temporary walkways with Detectable Edging where existing pavements or existing edging (that meets the requirements of MUTCD) are utilized as temporary walkways. Payment for temporary detectable edging, including approved barriers and channelizing devices, installed on existing pavements shall be included in Traffic Control-Lump Sum.

Regardless of the materials used, temporary walkways shall be constructed of sufficient thickness and durability to withstand the intended use for the duration of the construction project. If concrete or asphalt is used as the surface course for the walkway, it shall be a minimum of one and one-half inches (1-1/2") thick. Temporary walkways constructed across unimproved streets and drives shall be a minimum thickness of four inches (4") for concrete and three inches (3") for asphalt. Joints formed in concrete sidewalks shall be in accordance with [Section 441](#). Concrete surfaces shall have a broom finish.

If plywood is used as a walkway, it must be a minimum of three quarters of an inch (3/4") thick pressure treated and supported with pressure treated longitudinal joists spaced a maximum of sixteen inches (16") on center. The plywood shall be secured to the joist with galvanized nails or galvanized deck screws. Nails and screws shall be countersunk to prevent snagging or tripping the pedestrians. A slip resistant friction course shall be applied to any plywood surface that is used as a walkway. Any slip resistant material used shall have the prior written approval of the engineer.

The contractor may propose alternate types of Temporary Walkways provided the contractor can document that the proposed walkway meets the requirements of the "Americans with Disabilities Act Accessibility Guidelines for

Buildings and Facilities (ADAAG)". Alternate types of Temporary Walkways shall have the prior written approval of the engineer.

Temporary walkways shall be constructed and maintained so there are no abrupt changes in grade or terrain that could cause a tripping hazard or could be a barrier to wheelchair use. The contractor shall construct and maintain the walkway to ensure that joints in the walkway have a vertical difference in elevation of no more than one quarter (1/4") of an inch and that the horizontal joints have gaps no greater than one half (1/2") of an inch. The grade of the temporary walkway should parallel the grade of the existing walkway or roadway and the cross slope should be no greater than 2%.

A width of sixty (60") inches, if practical, should be provided throughout the entire length of any temporary walkway. The temporary walkway shall be a minimum width of forty eight inches (48"). When it is not possible to maintain a minimum width of sixty inches (60") throughout the entire length of temporary walkway, a sixty inch (60") by sixty inch (60") passing space should be provided at least every two hundred feet (200 Ft.), to allow individuals in wheelchairs to pass.

Temporary walkways shall be constructed on firm subgrade. Compact the subgrade according to [Section 209](#). Furnish and install any needed temporary pipes prior to constructing any walkway to ensure positive drainage away from or beneath the temporary walkway. Once the walkway is no longer required, remove any temporary materials and restore the area to the original conditions or as shown in the plans.

b. Temporary Curb Cut Wheelchair Ramps

Temporary curb cut wheelchair ramps shall be constructed in accordance with [Section 441](#) and Detail A-3. Ramps shall also include a detectable warning surface in accordance with Detail A-4. Other types of material for the construction of the temporary curb cut wheelchair ramps, including the detectable warning surface, may be used provided the contractor can provide documentation that the material to be used meets the requirements of the "Americans with Disabilities Act Accessibility Guidelines for Buildings and Facilities (ADAAG)". When a wheelchair ramp is no longer required, remove the temporary materials and restore the area to existing conditions or as shown in the plans. For the items required to restore the area to original conditions or as shown in the plans, measures for payment shall be covered by contract pay items. If pay items are not included in the contract, then payment for these items shall be included in Traffic Control-Lump Sum.

c. Temporary Audible Information Device

Temporary audible information devices, when shown in the plans, shall be installed in compliance with the "Americans with Disabilities Act Accessibility Guidelines for Buildings and Facilities (ADAAG)". The

devices shall be installed in accordance with the manufacturer's recommendations. Prior to installation, the contractor shall provide the engineer with a set of manufacturer's drawings detailing the proper installation procedures for each device. When no longer required, the devices shall remain the property of the contractor.

L. TRAFFIC SIGNALS

If the sequence of operations, staging, or the temporary traffic control plan requires the relocation or shifting of any components of an existing traffic signal system then any work on these traffic signals will be considered as part of Lump Sum-Traffic Control. The contractor becomes responsible for the maintenance of these traffic signals from the time that the system is modified until final acceptance. The maintenance of traffic signals that are not a part of the work and are not in conflict with any portion of the work shall not be the responsibility of the contractor.

When construction operations necessitate an existing traffic signal to be out of service, the Contractor shall furnish off-duty police officers to regulate and maintain traffic control at the site. Off-duty police officers should be used to regulate and maintain traffic control at signal sites when lane closures or traffic shifts block or restrict movements causing interference with normal road user flows and will not allow the activated traffic signal to guide the traffic through the signal site.

M. REMOVAL/REINSTALLATION OF MISCELLANEOUS ITEMS

In the prosecution of the Work, if it becomes necessary to remove any existing signs, markers, guardrail, etc. not covered by specific pay item, they shall be removed, stored and reinstalled, when directed by the Engineer, to line and grade, and in the same condition as when removed.

N. Signalized Intersections

Off duty police officers shall be used to regulate and maintain traffic control at functioning signalized intersections when lane closures or traffic shifts block or restrict movements causing interference with road user flows and will not allow the activated traffic signal to guide the traffic through the signal site. This work is considered incidental and shall be included in the overall price bid for traffic control.

150.3 SIGNS:

A. SIGNING REQUIREMENTS OF THE TEMPORARY TRAFFIC CONTROL (TTC) PLAN

When existing regulatory, warning or guide signs are required for proper traffic and pedestrian control the Contractor shall maintain these signs in accordance with the temporary traffic control (TTC) plan. The Contractor shall review the status of all existing signs, interim signs added to the work, and permanent sign installations that

are part of the work to eliminate any conflicting or non-applicable signage in the TTC Plan. The Contractor's review of all signs in the TTC Plan shall establish compliance with the requirements of the MUTCD and Section 150. Any conflicts shall be reported to the Engineer immediately and the WTCS shall take the necessary measures to eliminate the conflict.

The Contractor shall make every effort to eliminate the use of interim signs as soon as the Work allows for the installation of permanent signs.

All existing illuminated signs shall remain lighted and be maintained by the Contractor.

Existing street name signs shall be maintained at street intersections.

B. CONFLICTING OR NON-APPLICABLE SIGNS

Any sign(s) or portions of a sign(s) that are not applicable to the TTC plan shall be covered so as not to be visible to traffic or shall be removed from the roadway when not in use. The WTCS shall review all traffic shifts and changes in the traffic patterns to ensure that all conflicting signs have been removed. The review shall confirm that the highest priority signs have been installed and that signs of lesser significance are not interfering with the visibility of the high priority signs. High priority signs include signs for road closures, shifts, detours, lane closures and curves. Any signs, such as speed zones and speed limits, passing zones, littering fines and litter pick up, that reference activities that are not applicable due to the presence of the Work shall be removed, stored and reinstalled when the Work is completed.

Failure to promptly eliminate conflicting or non-applicable signs shall be considered as non-performance under [Subsection 150.08](#).

C. REMOVAL OF EXISTING SIGNS AND SUPPORTS

The Contractor shall not remove any existing signs and supports without prior approval from the Engineer. All existing signs and supports which are to be removed shall be stored and protected if this material will be required later in the work as part of the TTC plan. If the signs are not to be utilized in the work then the signs will become the property of the Contractor unless otherwise specified in the contract documents.

D. INTERIM GUIDE, WARNING AND REGULATORY SIGNS

Interim guide, warning, or regulatory signs required to direct traffic and pedestrians shall be furnished, installed, reused, and maintained by the Contractor in accordance with the MUTCD, the Plans, Special Provisions, Special Conditions, or as directed by the Engineer. These signs shall remain the property of the Contractor. The bottom of all interim signs shall be mounted at least seven (7') feet above the level of the pavement edge when the signs are used for long-term stationary operations as defined by Section 6G.02 of the MUTCD. Special Conditions under Subsection 150.11 may modify this requirement.

Portable signs may be used when the duration of the work is less than three (3) days or as allowed by the special conditions in Subsection 150.11. Portable signs shall be used for all punchlist work. All portable signs and sign mounting devices utilized in work shall be NCHRP 350 compliant.

Portable interim signs shall be mounted a minimum of one (1') foot above the level of the pavement edge for directional traffic of two (2) lanes or less and a minimum of seven (7') feet for directional traffic of three (3) or more lanes. Signs shall be mounted at the height recommended by the manufacturer's crashworthy testing requirements. Portable interim signs which are mounted at less than seven (7') feet in height may have two 18 inch x 18 inch fluorescent red-orange or orange-red warning flags mounted on each sign.

All regulatory sign blanks shall be rigid whether the sign is mounted as a portable sign, on a Type III barricade or as a permanent mount height sign.

Any permanent mount height interim sign that is designed to fold in half to cover a non-applicable message on the sign shall have reflectorized material on the folded over portion of the sign. The reflectorized material shall be orange in color with a minimum of ASTM Type I engineering grade sheeting with a minimum area of six inches by six inches (6" x 6") facing the direction of traffic at all times when the sign is folded.

Interim signs may be either English or metric dimensions.

E. EXISTING SPECIAL GUIDE SIGNS

Existing special guide signs on the Project shall be maintained until conditions require a change in location or legend content. When change is required, existing signs shall be modified and continued in use if the required modification can be made within existing sign borders using design requirements (legend, letter size, spacing, border, etc.) equal to that of the existing signs, or of [Subsection 150.03.E.2](#). Differing legend designs shall not be mixed in the same sign.

1. Special Guide Signs

Special guide signs are those expressway or freeway guide signs that are designed with message content (legend) that applies to a particular roadway location. When an existing special guide sign is in conflict with work to be performed, the Contractor shall remove the conflicting sign and reset it in a new, non-conflicting location which has been approved by the Engineer.

2. Interim Special Guide Signs

When it is not possible to utilize existing signs, either in place or relocated, the Contractor shall furnish, erect, maintain, modify, relocate, and remove new interim special guide signs in accordance with the Plans or as directed by the Engineer. Interim special guide signs that may be required in addition to, or a replacement for, existing expressway and freeway (interstate) signs shall be designed and fabricated in compliance with the minimum requirements for guide signing contained in Part 2E "Guide Signs Expressway" and Part 2F "Guide Signs Freeways" of the MUTCD, except that the minimum size of all letters and numerals in the names and places, streets and highways on all signs shall be 16 inches Series "E" initial upper-case and 12 inches lower-case. All interstate shields on these signs shall be 48 inches and 60 inches for two-numeral and three-numeral routes, respectively.

The road name of the exit or route shield shall be placed on the exit gore sign.

3. Interim Overhead Guide Sign Structures

Interim overhead special guide sign structures are not required to be lighted unless specifically required by the Plans. If lighting is required the sign shall be lighted as soon as erected and shall remain lighted, during the hours of darkness, until the interim sign is no longer required. The Contractor shall notify the Power Company at least thirty (30) days prior to desired connection to the power source.

4. Permanent Special Guide Signs

The installation of new permanent special guide signs and the permanent modification or resetting of existing special guide signs, when included in the contract, shall be accomplished as soon as practical to minimize the use of interim special guide signs. If lighting is required by the Plans, all new permanent overhead special guide signs shall be lighted as soon as erected.

F. MATERIALS- INTERIM SIGNS:

1. Posts

Permanent mounting height of seven (7') feet- Posts for all interim signs shall meet the requirements of Section 911 except that green or silver paint may be used in lieu of galvanization for steel posts or structural shape posts. Within the limits of a single project, all metal posts shall be the same color. Wood posts are not required to be pressure treated. Ground mounted sign(s) greater than nine (9) square feet shall be mounted on two posts.

Interim posts may be either metric or English in dimensions.

Posts for all interim signs shall be constructed to yield upon impact unless the posts are protected by guardrail, portable barrier, impact attenuator or other type of positive barrier protection. Unprotected posts shall meet the breakaway requirements of the "1994 AASHTO Standard Specifications for Structural Support for Highway Signs, Luminaries and Traffic Signals". Unprotected interim posts shall be spliced as shown in [Detail 150-F](#) unless full length unspliced posts are used.

Unprotected post splices will not be permitted any higher than four inches above the ground line to lessen the possibility of affecting the undercarriage of a vehicle. Installation of posts may require establishment of openings in existing pavements, islands, shoulders etc.

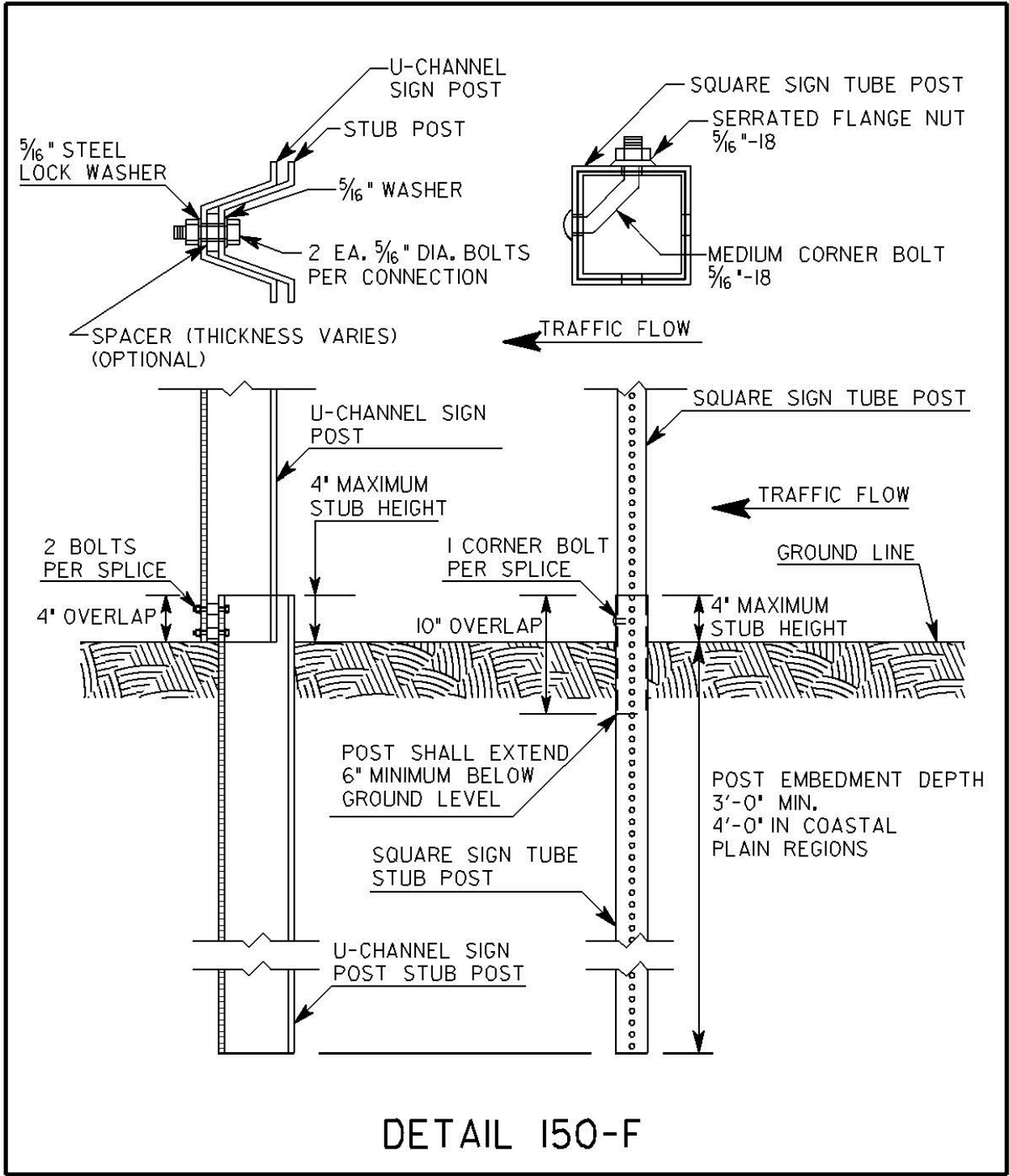

2. **Sign Blanks And Panels- Permanent mounting height of seven (7') feet-** All sign blanks and panels shall conform to [Section 912](#) of the Specifications except that blanks and panels may be ferrous based or other metal alloys. Type 1 and Type 2 sign blanks shall have a minimum thickness of 0.08 inches regardless of the sign type used. Alternative sign blank materials (composites, poly carbonates, fiberglass reinforced plastics, recycled plastics, etc.) shall have a letter of approval from the Office of Materials and Research for use as interim construction signs before these materials are allowed to be incorporated into the work unless these rigid sign blanks are currently approved as a crashworthy sign blank material under QPL 34. The back side of sign panels shall be painted orange to prevent rust if other metals are used in lieu of aluminum. Plywood blanks or panels will not be permitted. The use of flexible signs will not be permitted for permanent mount height signs.

Interim blanks and panels may be either metric or English in dimensions.

3. **Portable Sign Mounting Devices, Portable Sign Blanks-**
All portable sign mounting devices and sign blanks utilized in the work shall be NCHRP 350 Test Level III compliant. All portable sign mounting devices and sign blanks shall be from the Qualified Products List. Any sign or sign mounting device shall have an identifying decal, logo, or manufacturer's stamping that clearly identifies the device as NCHRP 350 compliant. The required decal, logo or manufacturer's stamping shall not be displayed on the message face of the sign. The Contractor may be required to provide certification from the Manufacturer as proof of NCHRP 350 compliance. All portable signs shall be mounted according to height requirements of [Subsection 150.03.D](#).

G. SIGN VISIBILITY AND OFFSETS

All existing, interim and new permanent signs shall be installed so as to be completely visible for an advance distance in compliance with the MUTCD. Any clearing required for maintaining the line of sight to existing, interim or permanent signs shall be done as part of the requirements of the TTC plan. The clearing shall include any advance warning signs, both interim and permanent, that are installed as a part of the work including advance warning signs that are installed outside the limits of the project. Any sign installed behind W-beam or T-beam guardrail with non-breakaway posts shall be installed with the leading edge of the sign a minimum of four feet and three inches (4'3") behind the face of the guardrail with five feet (5') of clearance being desirable. Limbs, brush, construction equipment and materials shall be kept clear of the driver's line of sight to all signs that are part of the TTC plan.

H. ADVANCE WARNING SIGNS:

1. **All Type Of Highways**
Advance warning signs shall be placed ahead of the work area in accordance with Part VI of the MUTCD and shall include a series of at least three advance road work (W20-1) signs placed at the termini of the project. The series shall

have the legend ROAD WORK (1500 FEET, 1000 FEET, AND 500 FEET). At grade intersecting roadways and on-ramps shall be signed with a minimum of one ROAD WORK AHEAD sign.

When work terminates at a "T" intersection, a minimum of one "ROAD WORK AHEAD" sign shall be placed in advance of the intersection and one "END ROAD WORK" sign shall be placed at the termination end of the intersection. Field conditions may require the use of additional warning signage.

Advanced Warning Signs on State Routes shall be a minimum dimension of 48 inches x 48 inches. When a State Route intersects a project which consists of adding travel lanes, reconstructing an existing roadway or new location work, the State Route approaches shall have a minimum of three (W20-1) advanced warning signs (1500 ft., 1000 ft., 500 ft.). The termination end of an intersecting State Route shall have END ROAD WORK signage.

The W20-1 signs shall be placed at the termini of the project or sufficiently in advance of the termini to allow for lane shifts, lane closures and other activities which may also require advanced warning signs. The advanced warning signs for the project should not overlap with the advanced warning signs for lane shifts, lane closures, etc.

The length of a work zone should be held to the minimum length required to accomplish the work. If a project has multiple individual worksites within the overall limits of the project, each site should be signed individually if the advance warning signs for each site can be installed without overlapping an adjacent worksite. As soon as the work is completed at any individual site the warning signs shall be removed from that site. Clean-up work and punchlist work shall be performed with portable signage.

Project mileage indicated on the G20-1 sign shall be the actual project mileage rounded up to the nearest whole mile. Projects less than two (2) miles in length or individual worksites that are part of a multiple worksite project may delete this sign. The G20-1 sign shall be 60" X 36" and the G20-2 sign shall be 48" X 24".

2. Interstate, Limited Access And Multilane Divided Highways

In addition to the W20-1 signs required at 500 ft., 1000 ft. and 1500 ft., multi-lane divided highways shall also have additional advanced warning signs installed with the legend "ROAD WORK (2 MILES, 1 MILE and 1/2 MILE). All construction warning signs on divided highways shall be double indicated (i.e., on the left and right sides of the roadway.) If the use of the ½ mile, 1 mile and 2 mile advanced warning signs cause an overlap with other work or do not benefit field conditions then the Engineer may review the use of these signs and eliminate their installation. When the posted speed limit is 50 MPH or less,

the ½ mile, 1 mile and 2 mile signs should be eliminated especially in urban areas.

The W20-1 advance warning signs for ROAD WORK 500 FEET; 1000 FEET; and 1500 FEET shall be temporarily covered when work involving the advanced warning signs for lane shifts and lane closures overlap these signs. The ROAD WORK ½ MILE, ROAD WORK 1 MILE, and ROAD WORK 2 MILES shall be in place when the 500, 1000 and 1500 foot signs are temporarily covered.

When the temporary traffic control zone already has advanced warning (W20-1) signs installed the W20-1 signs required for lane closures under Standard 9106 should be eliminated.

RAMP WORK ON LIMITED ACCESS HIGHWAYS: The work zone shall not be signed for the entire length of the mainline of a limited access highway when only short individual worksites, interchange or ramp work is being performed.

When work is restricted to ramp reconstruction or widening activities, the advance warning signs on the mainline section of the limited access highway shall be limited to the use of portable advance warning signs. These portable advance warning signs shall only be utilized when work activity is within the gore point of the ramp and the mainline traveled way or work is active in the accel/decel lane adjacent to the mainline traveled way. Portable advance warning signs (W20-1; 1500ft. /1000 ft. /500ft.) shall be installed on the traveled way of the limited access highway when the above conditions are present. The advance warning signs shall be installed only in one direction where work is active. All portable signs shall be double indicated. When work is not active, the ramp work shall be advanced warned by the use of a single 48 inch X 48 inch "RAMP WORK AHEAD" sign along the right shoulder of the mainline traveled way prior to the beginning of the taper for the decel lane. The "RAMP WORK AHEAD" sign shall be mounted at seven (7') feet in height. Differences in elevation shall be in compliance with the requirements of [Subsection 150.06](#) prior to the removal of the portable (W20-1) advanced warning signs from the mainline.

The G20-1 sign shall be eliminated on limited access highways when the work involves only ramp work, bridge reconstruction, bridge painting, bridge joint repairs, guardrail and anchor replacement or other site specific work which is confined to a short section of limited access highway.

I. PORTABLE CHANGEABLE MESSAGE SIGN

Unless specified as a paid item in the contract the use of a portable changeable message sign will not be required. When specified, a portable changeable message sign (PCMS) shall meet the minimum requirements of [Section 632](#) and the MUTCD. The maximum amount of messages allowed to be flashed on one PCMS is two phases (flashes). The language and the timing of

the messages shall comply with the MUTCD and Section 632.

When used as an advanced device the PCMS should typically be placed ahead of the construction activities. If the PCMS is used as a substitute for another device then the requirements for the other device apply.

J. FLASHING BEACON

The flashing beacon assembly, when specified, shall be used in conjunction with construction warning signs, regulatory, or guide signs to inform traffic of special road conditions which require additional driver attention. The flashing beacon assembly shall be installed in accordance with the requirements of [Section 647](#).

K. RUMBLE STRIP SIGNAGE

Signage for rumble strips located in the travelway shall be as required in [Subsection 150.01.C](#) and [Subsection 150.02.A.9](#).

L. LOW/SOFT SHOULDER SIGNAGE

Low or soft shoulder signs shall be utilized in accordance with the following conditions:

CONSTRUCTION/RECONSTRUCTION PROJECTS:

"LOW/SOFT SHOULDER" signs shall be erected when a difference in elevation exceeds one (1") inch but does not exceed three (3") inches between the travelway and any type of shoulder unless the difference in elevation is four (4') feet or greater from the edge of the traveled way.

The spacing of the signs shall not exceed one (1) mile and the signs shall be placed immediately past each crossroad intersection. The "Low/Soft" signs shall remain in place until the difference in elevation is eliminated and the shoulder has been dressed and permanently grassed for a minimum of thirty (30) calendar days. These signs shall be furnished, installed, maintained and removed by the Contractor as part of Traffic Control-Lump Sum. These signs shall be orange with black borders and meet the reflectorization requirements of [Subsection 150.01.D](#).

"SHOULDER DROP-OFF" (W8-9a) signs shall be used when a difference in elevation, less than four (4') feet from the traveled way, exceeds three (3") inches and is not protected by positive barrier protection. These warning signs shall be placed in advance of the drop-off. For a continuous drop-off condition, the W8-9a) signs shall, as a minimum, be spaced in accordance with the above requirements for "Low/soft shoulder" signs.

PROJECTS CONSISTING PRIMARILY OF ASPHALTIC CONCRETE RESURFACING ITEMS:

"LOW/SOFT SHOULDER" signs shall be erected when a difference in elevation

exceeds one (1") inch but does not exceed three (3") inches between the travelway and any type of shoulder unless the difference in elevation is four (4') feet or greater from the edge of the traveled way.

SHOULDER BUILDING INCLUDED IN THE CONTRACT: "Low/Soft Shoulder" signs shall be erected as per the requirement of Standards 9102, 9106, and 9107. "Shoulder Drop-off" signs (W8-9a) shall be erected as per the requirements of the MUTCD. These signs shall be maintained until the conditions requiring their installation have been eliminated. The Contractor shall remove all interim warning signs before final acceptance.

SHOULDER BUILDING NOT INCLUDED IN THE CONTRACT: The Department will furnish the "Low/Soft Shoulder" signs, "Shoulder Drop-off" signs and the posts. The signs shall be erected to meet the minimum requirements of [Subsection 150.03](#). The Contractor shall include the cost of furnishing installation hardware (bolts, nuts, and washers), erection and maintenance of the signs in the bid price for Traffic Control- Lump Sum. The Contractor shall maintain the signs until final acceptance. The Department will remove the signs.

LAU/LAR PROJECTS SHOULDER BUILDING NOT INCLUDED IN THE CONTRACT: The Contractor will furnish, install and maintain LOW/SOFT SHOULDER signs (yellow with black borders, ASTM Type III or IV) at the appropriate spacing, until Final Acceptance of the project by the Department. After Final Acceptance by the Department the signs will become the property and responsibility of the local government.

M. BUMP SIGNAGE:

MULTI-LANE DIVIDED HIGHWAYS: A bump sign (W8-1) shall be utilized when a transverse joint in the pavement structure has a vertical difference in elevation of three quarters (3/4") of an inch or greater in depth with no horizontal taper to ramp the traffic from one elevation to the other. This condition typically occurs at approach slabs during pavement milling operations and at transverse joints in asphaltic pavement lifts.

TWO-LANE TWO-WAY HIGHWAYS: A bump sign (W8-1) shall be utilized when a transverse joint in the pavement structure has a vertical difference in elevation that exceeds one and three quarters (1-3/4") inches in depth with no horizontal taper to ramp the traffic from one elevation to the other. This includes utility and storm drainage repairs that require concrete placement for patching and/or steel plating.

The (W8-1) sign shall be placed sufficiently in advance to warn the motorist of the condition.

N. PEDESTRIAN SIGNAGE:

Appropriate signs as described in the MUTCD shall be maintained to allow safe

passage of pedestrian traffic or to advise pedestrians of walkway closures (Refer to MUTCD Figures TA-28 and TA-29 for guidance). Advance closure signing should be placed at intersections rather than midblock locations so that pedestrians are not confronted with midblock work sites that will induce them to attempt skirting the work site or making a midblock crossing. Signs and other devices mounted lower than seven (7) feet above the temporary pedestrian walkway shall not project more than four (4) inches into the accessible pedestrian facilities. Signs and other devices shall be placed such that they do not narrow any pedestrian passage to less than 48 inches.

150.4 PAVEMENT MARKINGS

A. GENERAL

Full pattern pavement markings in accordance with [Section 652](#) and in conformance with Section 3A and 3B, except 3B.02, of the MUTCD are required on all courses before the roadway is opened to traffic. No passing zones shall be marked to conform to [Subsection 150.04.E](#). During construction and maintenance activities on all highways open to traffic, both existing markings and markings applied under this Section shall be fully maintained until Final Acceptance. If the pavement markings are, or become, unsatisfactory in the judgment of the Engineer due to wear, weathering, or construction activities, they shall be restored immediately.

1. Resurfacing Projects

Pavement markings shall be provided on all surfaces that are placed over existing markings. Interim and final markings shall conform in type and location to the markings that existed prior to resurfacing unless changes or additions are noted in the Contract. The replacement of parking spaces will not be required unless a specific item or note has been included in the Contract. Any work to make additions to the markings that existed prior to resurfacing is to be considered as extra work.

2. Widening And Reconstruction Projects

If the lane configuration is altered from the preconstruction layout then pavement markings will be as required by the plans or the Engineer.

3. New Location Construction Projects

Pavement marking plans will be provided.

B. MATERIALS

All traffic striping applied under this Section shall be a minimum four inches in width or as shown in plans and shall conform to the requirements of [Section 652](#), except as modified herein. Raised pavement markers (RPMs) shall meet the requirements of [Section 654](#). Markings on the final surface course, which must be removed, shall be a removable type. The Contractor will be permitted to

use paint, thermoplastic, or tape on pavement which is to be overlaid as part of the project, unless otherwise directed by the Engineer. Partial (skip) reflectorization (i.e. reflectorizing only a portion of a stripe) will not be allowed.

C. INSTALLATION AND REMOVAL OF PAVEMENT MARKINGS:

INSTALLATION: All pavement markings, both interim and permanent, shall be applied to a clean surface. The Contractor shall furnish the layout and preline the roadway surface for the placement of pavement markings applied as part of the temporary traffic control plan. All interim marking tape and RPM's on the final surface shall be removed prior to the placement of the final markings.

The Contractor shall sequence the work in such a manner as to allow the installation of markings in the final lane configuration at the earliest possible stage of the work.

REMOVAL: Markings no longer applicable shall be removed in accordance with [Subsection 656.3.05](#).

THE ELIMINATION OF CONFLICTING PAVEMENT MARKINGS BY OVERPAINTING WITH UNAPPROVED PAINT OR ANY TYPE OF LIQUID ASPHALT IS NOT ACCEPTABLE.

INTERMEDIATE SURFACE: Interim markings shall be removed by methods that will cause minimal damage to the pavement surface while also ensuring that traveling public will not be confused or misdirected by any residual markings remaining on the intermediate surface. The use of approved black-out tape and black-out paint (manufactured for the sole purpose of covering existing pavement markings) may be permitted on some interim surfaces, provided the results are satisfactory to the Engineer.

FINAL SURFACE: No interim paint or thermoplastic markings will be permitted on any final surface unless the interim markings are in alignment with the location of the permanent markings and the interim marking will not interfere or adversely affect placement of the permanent markings. The proposed method of removal for layout errors that require markings to be removed from the final surface shall have the prior approval of the Engineer. Any damage to the final pavement surface caused by the pavement marking removal process shall be repaired at the Contractor's expense by methods acceptable and approved by the Engineer. [Subsection 400.3.06.C](#) shall apply when corrective measures are required. The use of black-out tape or black-out paint will not be permitted under any circumstance to correct layout errors on any final surface.

Traffic shifts that are done on the final surface shall be accomplished using interim traffic marking tape that can be removed without any blemishing of the final surface. Interim traffic marking tape shall be used on any of the following final surfaces; asphaltic concrete, Portland cement concrete, and bridge deck surfaces. The contractor may propose alternate traffic markings and removal methods on the final surface. Submitted proposals shall include the type

of material, method of removal and a cost comparison to the traffic marking tape method. Prior to any approval, the contractor shall field demonstrate to the satisfaction of the Engineer that the proposed traffic markings can be removed without any blemishing of the final surface. If the proposal is determined to be acceptable, a supplemental agreement will be executed prior to the installation of the proposed alternate traffic markings. The supplemental agreement shall denote the type of traffic marking materials, method of removal and any cost and/or time savings to the Department. The Department will not consider or participate in any cost increase that may result from implementing the proposed alternate method.

PAY FACTOR REDUCTION FOR ASPHALTIC CONCRETE FINAL SURFACES: When the correction of an error in the layout of the final pavement markings requires the final surface to be grounded, blemished, scarred, or polished the pay factor shall be reduced to 0.95 for the entire surface area of the final topping that has a blemish, polished or a scarred surface. The reduced pay factor shall not be confined to only the width and length of the stripe or the dimensions of the blemished areas, the whole roadway surface shall have the reduced pay factor applied. The area of the reduced pay factor shall be determined by the total length and the total width of the roadway affected. If the affected area is not corrected, the reduction in pay shall be deducted from the final payment for the topping layer of asphaltic concrete. The Engineer shall make the final determination whether correction or a reduced pay factor is acceptable.

The eradication of pavement markings on intermediate and final concrete surfaces shall be accomplished by a method that does not grind, polish, or blemish the surface of the concrete. The method used for the removal of the interim markings shall not spall chip the joints in the concrete and shall not damage the sealant in the joints. Any joint or sealant repairs shall be included in the bid price for Traffic Control-Lump Sum. The proposed method of removal shall have the prior approval of the Engineer.

Failure to promptly remove conflicting or non-applicable pavement markings shall be considered as non-performance under [Subsection 150.08](#).

PREPARATION AND PLANNING FOR TRAFFIC SHIFTS: When shifting of traffic necessitates removal of centerline, lane lines, or edge lines, all such lines shall be removed prior to, during, or immediately after any change so as to present the least interference with traffic. Interim traffic marking tape shall be used as a temporary substitute for the traffic markings being removed.

Before any change in traffic lane(s) alignment, marking removal equipment shall be present on the project for immediate use. If marking removal equipment failures occur, the equipment shall be repaired or replaced (including leasing equipment if necessary), so that the removal can be accomplished without delay.

Except for the final surface, markings on asphaltic concrete may be obliterated by an overlay course, when approved by the Engineer. When an asphaltic concrete overlay is placed for the sole purpose of eliminating conflicting markings and the in place asphaltic concrete section will allow, said overlay will be eligible for payment only if designated in the Plans. Overlays to obliterate lines will be paid for only once and further traffic shifts in the same area shall be accomplished with removable markings. Only the minimum asphaltic concrete thickness required

to cover lines will be allowed. Excessive build-up will not be permitted. When an overlay for the sole purpose of eliminating conflicting markings is not allowed, the markings no longer applicable shall be removed in accordance with [Subsection 656.3.05](#).

D. RAISED PAVEMENT MARKERS

Raised pavement markers (RPMs) are required as listed below for all asphaltic concrete pavements before the roadway is open to traffic. On the final surface, RPM's shall be placed according to the timeframes specified in 150.04 E. for full pattern pavement markings except Interstate Highways where RPM's shall be placed and/or maintained when the roadway is open to traffic. When Portland Cement Concrete is an intermediate or final surface and is open to traffic, one calendar day is allowed for cleaning and drying before the installation of RPMs is required.

Raised pavement markers are not allowed on the right edge lines under any situation.

1. Interstate Highways

Retro-reflective raised pavement markers (RPM's) shall be placed and/or maintained on intermediate pavement surfaces on all interstate highways that are open to traffic. This includes all resurfacing projects along with widening and reconstruction projects. The spacing and placement shall be as required for MULTI-LANE DIVIDED HIGHWAYS.

2. Multi-Lane Divided Highways

Retro-reflective raised pavement markers (RPMs) shall be placed and/or maintained on intermediate pavement surfaces on all multi-lane divided highways that are opened to traffic when these roadways are being widened or reconstructed. Two lane-two way roadways that are being widened to a multi-lane facility, whether divided or undivided, are included in this provision. Projects consisting primarily of asphalt resurfacing items or shoulder widening items are excluded from this requirement. The RPMs shall be placed as follows:

a. SUPPLEMENTING LANE LINES

80 foot center on skip lines with curvature less than three degrees. (Includes tangents)

40 foot centers on solid lines and all lines with curvature between three degrees and six degrees.

20 foot centers on curves over six degrees. 20

foot centers on lane transitions or shifts.

b. SUPPLEMENTING RAMP GORE LINES

20 foot centers, two each, placed side by side.

c. OTHER LINES

As shown on the plans or directed by the Engineer.

3. Other Highways

On other highways under construction RPMs shall be used and/or maintained on intermediate pavement surfaces as follows:

a. SUPPLEMENTING LANE LINES AND SOLID LINES

40 foot centers except on lane shifts. (When required in the Plans or Contract.)

20 foot centers on lane shifts. (Required in all cases.)

b. SUPPLEMENTING DOUBLE SOLID LINES

40 foot centers (one each beside each line) except on lane shifts. (When required in the Plans or Contract.)

20 foot centers on lane shifts. (Required in all cases.)

E. EXCEPTIONS FOR INTERIM MARKINGS

Some exceptions to the time of placement and pattern of markings are permitted as noted below; however, full pattern pavement markings are required for the completed project.

1. Two-Lane, Two-Way Roadways

a. SKIP LINES

All interim skip (broken) stripe shall conform to [Section 652](#) except that stripes shall be at least two feet long with a maximum gap of 38 feet. On curves greater than six degrees, a one-foot stripe with a maximum gap of 19 feet shall be used. In lane shift areas solid lines will be required. Interim skip lines shall be replaced with markings in full compliance with [Section 652](#) prior to expiration of the 14 calendar day period.

Interim raised pavement markers may be substituted for the interim skip (broken) stripes. If raised pavement markers are substituted for the two foot interim skip stripe, three markers spaced at equal intervals over a two foot distance will be required. No separate payment will be made if the interim raised pavement markers are substituted for interim skip lines.

Interim raised pavement markers shall be retro-reflective, shall be the same color as the pavement markers for which they are substituted, and shall be visible during daytime.

The type of interim marker and method of attachment to the pavement shall be approved by the Office of Materials and Research but in no case will the markers be attached by the use of nails. Flexible reflective markers, Type 14 or Type 15, may be used for a maximum of fourteen (14) calendar days as an interim marker. Any flexible reflective markers in use shall be from the qualified products list (QPL).

The interim raised pavement markers shall be maintained until the full pattern pavement markings are applied. At the time full pattern markings are applied the interim raised markers shall be removed in a manner that will not interfere with application of the full pattern pavement markings.

b. **NO PASSING ZONES-TWO-LANE, TWO-WAY ROADWAYS**

Passing zones shall be re-established in the locations existing prior to resurfacing. No changes to the location of passing zones shall be done without the written approval of the Engineer. For periods not to exceed three calendar days where interim skip centerlines are in place, no-passing zones shall be identified by using post or portable mounted DO NOT PASS regulatory signs (R4-1 24" x 30") at the beginning and at intervals not to exceed ½ mile within each no-passing zone. A post or portable mounted PASS WITH CARE regulatory sign (R4-1 24" x 30") shall be placed at the end of each no-passing zone. Post mounted signs shall be placed in accordance with the MUTCD. Portable signs shall conform to the requirements of the MUTCD and shall be NCHRP 350 compliant. Portable signs shall be secured in such a manner to prevent misalignment and minimize the possibility of being blown over by weather conditions or traffic.

On new location projects and on projects where either horizontal or vertical alignments has been modified, the location of No-Passing Zones will be identified by the Engineer.

c. **EDGELINES**

1) **Bituminous Surface Treatment Paving**

Edgelines will not be required on intermediate surfaces (including asphaltic concrete leveling for bituminous surface treatment paving) that are in use for a period of less than 60 calendar days except at bridge approaches, on lane transitions, lane shifts, and in such other areas as determined by the Engineer. On the final surface, edgelines shall be placed within 30 calendar days of the time that the final surface was placed.

2) **All Other Types of Pavement**

Edgelines will not be required on intermediate surfaces that are in use for a period of less than 30 calendar days except at bridge approaches, on lane transitions, lane shifts, and in such other areas as determined by the

Engineer. On the final surface, edgelines shall be placed within 14 calendar days of the time that the surface was placed.

2. Multi-Lane Highways – With No Paved Shoulder(S) Or Paved Shoulder(S) Four Feet Or Less
 - a. UNDIVIDED HIGHWAYS (INCLUDES PAVED CENTER TURN LANE)
 - 1) Centerlines and No-Passing Barrier-Full Pattern centerlines and no-passing barriers shall be restored before opening to traffic.
 - 2) Lanelines- Interim skip (broken) stripe as described in [Subsection 150.04E.1.a.](#) may be used for periods not to exceed three calendar days. Skiplines are not permitted in lane shift areas. Solid lines shall be used.
 - 3) Edgelines- Edgelines shall be placed on intermediate and final surfaces within three calendar days of obliteration.
 - b. DIVIDED HIGHWAYS (GRASS OR RAISED MEDIAN)
 - 1) Lanelines- Full pattern skip stripe shall be restored before opening to traffic. Skip lines are not permitted in lane shift areas. Solid lines shall be required.
 - 2) Centerline/Edgeline- Solid lines shall be placed on intermediate and final surfaces within three calendar days of obliteration.
3. Limited Access Roadways And Roadways With Paved Shoulders Greater Than Four Feet
 - a. Same as [Subsection 150.04.E.2](#) except as noted in (b) below.
 - b. EDGELINES-
 - 1) Asphaltic Concrete Pavement- Edgelines shall be placed on intermediate and final surfaces prior to opening to traffic.
 - 2) Portland Cement Concrete Pavement- Edgelines shall be placed on any surface open to traffic no later than one calendar day after work is completed on a section of roadway. All water and residue shall be removed prior to daily striping.
4. Ramps For Multi-Lane Divided Highways

A minimum of one solid line edge stripe shall be placed on any intermediate surface of a ramp prior to opening the ramp to traffic. The other edge stripe may be omitted for a maximum period of three (3) calendar days on an intermediate surface. Appropriate channelization devices shall be spaced at a maximum of twenty-five (25') feet intervals until the other stripe has

been installed.

The final surface shall have both stripes placed prior to opening the ramp to traffic.

5. MISCELLANEOUS PAVEMENT MARKINGS:

FINAL SURFACE: School zones, railroads, stop bars, symbols, words and other similar markings shall be placed on final surfaces conforming to [Section 652](#) within fourteen (14) calendar days of completion of the final surface. Final markings shall conform to the type of pay item in the plans. When no pay item exists in the plans the final markings shall conform to [Section 652](#) for painted markings.

INTERMEDIATE SURFACE: Intermediate surfaces that will be in use for more than forty-five (45) calendar days shall have the miscellaneous pavement markings installed to conform to the requirement of [Section 652](#). Under Subsection 150.11, Special Conditions, or as directed by the Engineer these markings may be eliminated.

F. MOBILE OPERATIONS

When pavement markings (centerlines, lane lines, and edgelines) are applied in a continuous operation by moving vehicles and equipment, the following minimum equipment and warning devices shall be required. These devices and equipment are in addition to the minimum requirements of the MUTCD.

1. All Roadways

All vehicles shall be equipped with the official slow moving vehicle symbol sign. All vehicles shall have a minimum of two flashing or rotating beacons visible in all directions. All protection vehicles shall have an arrow panel mounted on the rear. All vehicles requiring an arrow panel shall have, as a minimum, a Type B panel. All vehicle mounted signs shall be mounted with the bottom of the sign a minimum height of forty-eight inches (48") above the pavement. All sign legends shall be covered or removed from view when work is not in progress.

2. Two-Lane Two-Way Roadways

a. Lead Vehicles

The lead vehicle may be a separate vehicle or the work vehicle applying the pavement markings may be used as the lead vehicle. The lead vehicle shall have an arrow panel mounted so that the panel is easily visible to oncoming (approaching) traffic. The arrow panel should typically operate in the caution mode.

b. Work Vehicles

The work vehicle(s) applying markings shall have an arrow panel mounted on the rear. The arrow panel should typically operate in the caution mode. The work vehicle placing cones shall follow directly behind the work vehicle applying the markings.

c. Protection Vehicles

A protection vehicle may follow the cone work vehicle when the cones are being placed and may follow when the cones are being removed.

3. MULTI-LANE ROADWAYS

A lead vehicle may be used but is not required. The work vehicle placing cones shall follow directly behind the work vehicle applying the markings. A protection vehicle that does not function as a work vehicle should follow the cone work vehicle when traffic cones are being placed. A protection vehicle should follow the cone work vehicle when the cones are being removed from the roadway. Protection vehicles shall display a sign on the rear of the vehicle with the legend PASS ON LEFT (RIGHT).

INTERSTATES AND LIMITED ACCESS ROADWAYS: A protection vehicle shall follow the last work vehicle at all times and shall be equipped with a truck mounted attenuator that is certified for impacts not less than 62 mph in accordance with NCHRP350 Test Level Three (3).

150.5 CHANNELIZATION

A. GENERAL

Channelization shall clearly delineate the travelway through the work zone and alert drivers and pedestrians to conditions created by work activities in or near the travelway. Channelization shall be done in accordance with the plans and specifications, the MUTCD, and the following requirements.

All Channelization Devices utilized on any project shall be NCHRP 350 compliant. Any device used on the Work shall be from the Qualified Products List. All devices utilized on the work shall have a decal, logo, or manufacturer's stamping that clearly identifies the device as NCHRP 350 compliant. The Contractor may be required to furnish certification from the Manufacturer for any device to prove NCHRP 350 compliance.

1. Types of Devices Permitted for Channelization in Construction Work Zones:

a. DRUMS:

- 1) DESIGN: Drums shall meet the minimum requirement of the MUTCD and shall be reflectorized as required in [Subsection 150.01.D](#). The upper edge of the top reflectorized stripe on the drum shall be

located a minimum of 33 inches above the surface of the roadway. A minimum drum diameter of 18 inches shall be maintained for a minimum of 34 inches above the roadway.

- 2) APPLICATION: Drums shall be used as the required channelizing device to delineate the full length of a lane closure, shift, or encroachment, except as modified by this Subsection.
- 3) TRANSITION TAPERS FOR LANE CLOSURES: Drums shall be used on all transition tapers. The minimum length for a merging taper for a lane closure on the travelway shall be as shown in Table 150-1:

TABLE 150-1

| Posted Speed Limit, MPH | Lane Width 9 Feet | Lane Width 10 Feet | Lane Width 11 Feet | Lane Width 12 Feet | Maximum Drum Spacing in Tapers, (Feet) |
|----------------------------------|-------------------|--------------------|--------------------|--------------------|--|
| Minimum Taper Length (L) in Feet | | | | | |
| 20 | 60 | 70 | 75 | 80 | 20 |
| 25 | 95 | 105 | 115 | 125 | 25 |
| 30 | 135 | 150 | 165 | 180 | 30 |
| 35 | 185 | 205 | 225 | 245 | 35 |
| 40 | 240 | 270 | 295 | 320 | 40 |
| 45 | 405 | 450 | 495 | 540 | 45 |
| 50 | 450 | 500 | 550 | 600 | 50 |
| 55 | 495 | 550 | 605 | 660 | 55 |
| 60 | 540 | 600 | 660 | 720 | 60 |
| 65 | 585 | 650 | 715 | 780 | 65 |
| 70 | 630 | 700 | 770 | 840 | 70 |
| 75 | 675 | 750 | 825 | 900 | 75 |

If site conditions require a longer taper then the taper shall be lengthened to fit particular individual situations.

The length of shifting tapers should be at least ½ L.

The length of a closed lane or lanes, excluding the transition taper(s), shall be limited to a total of two (2) miles. Prior approval must be obtained from the Engineer before this length can be increased.

Night time conditions: When a merge taper exists into the night all drums located in the taper shall have, for the length of the taper only, a six (6") inch fluorescent orange (ASTM Type VI, VII, VIII, IX or X) reflectorized top stripe on each drum. The top six-inch stripe may be temporarily attached to the drum while in use in a taper. The Engineer may allow the fluorescent orange

reflectorized six (6") inch top stripe on each drum in a merging taper to remain in place during daylight hours provided there is a lane closure(s) with a continuous operation that begins during one nighttime period and ends during another nighttime period. All drums that have the six-inch top stripe permanently attached shall not be used for any other conditions.

Multiple Lane Closures:

- (a) A maximum of one lane at a time shall be closed with each merge taper.
- (b) A minimum tangent length of 2 L shall be installed between each individual lane closure taper.

4) LONGITUDINAL CHANNELIZATION: Drums shall be spaced as listed below for various roadside work conditions except as modified by [Subsection 150.06](#). Spacing shall be used for situations meeting any of the conditions listed as follows:

(a) 40 FOOT SPACING MAXIMUM

- (1) For difference in elevation exceeding two inches.
- (2) For heeled sections no steeper than 4:1 as shown in [Subsection 150.06, Detail 150-E](#).

(b) 80 FOOT SPACING MAXIMUM

- (1) For difference in elevation of two inches or less.
- (2) Flush areas where equipment or workers are within ten feet of the travel lane.

(c) 200 FOOT SPACING MAXIMUM: Where equipment or workers are more than ten feet from travel lane. Lateral offset clearance to be four feet from the travel lane.

- (1) For paved areas eight feet or greater in width that are paved flush with a standard width travel lane.
- (2) For disturbed shoulder areas not completed to typical section that are flush to the travel lane and considered a usable shoulder.

REMOVAL OF DRUMS: Drums may be removed after shoulders are completed to typical section and grassed. Guardrail and other safety devices shall be installed and appropriate signs advising of conditions such as soft or low shoulder shall be posted before the drums are removed.

b. VERTICAL PANELS

- 1) DESIGN: All vertical panels shall meet the minimum requirements of the MUTCD. All vertical panels shall have a minimum of 270 square inches of retro-reflective area facing the traffic and shall be mounted with the top of the reflective panel a minimum of 36" above the roadway.
- 2) APPLICATION: Lane encroachment by the drum on the travelway should permit a remaining lane width of ten feet. When encroachment reduces the travelway to less than ten feet, vertical panels shall be used to restore the travelway to ten feet or greater. No other application of vertical panels will be permitted.

c. CONES

- 1) DESIGN: All cones shall be a minimum of 28 inches in height regardless of application and shall meet the requirement of the MUTCD. Reflectorization may be deleted from all cones.
- 2) APPLICATION: For longitudinal channelizing only, cones will be permitted for daylight closures or minor shifts. (Drums are required for all tapers.) The use of cones for nighttime work will not be permitted. Cones shall not be stored or allowed to be visible on the worksite during nighttime hours.

d. BARRICADES

DESIGN: Type III barricades shall meet the minimum requirements of the MUTCD and shall be reflectorized as required in [Subsection 150.01.D](#). The Contractor has the option of choosing Type III barricades from the Qualified Products List or the Contractor may utilize generic barricades that are approved by the Federal Highway Administration (FHWA). When barricades have been specifically crash tested with signs attached, the contractor has the responsibility to attach the signs as per the manufacturer's recommendations to ensure crashworthiness. If signs are attached to generic barricades or to barricades from the Qualified Products List (QPL) that have not been crash tested with signs attached then the responsibility for crashworthiness and the liability for mounting these signs to the barricades are assumed by the Contractor and the Contractor shall certify that the barricades are crashworthy under FHWA workzone guidelines for NCHRP 350 crashworthy compliance. Any generic barricades used in the work shall be stamped or stenciled to show compliance with NCHRP 350. The use of Type I and Type II barricades will not be permitted.

- 1) APPLICATION: Type III barricades shall be placed as required by the plans, the Standards, and as directed by the Engineer. All signs mounted on barricades shall be mounted to comply with the requirements of the MUTCD and NCHRP 350 Test Level III. NCHRP 350 crashworthy compliance may require that rigid signs be mounted separate from the Type III barricade.

When a barricade is placed so that it is subject to side impact from a vehicle, a drum shall be placed at the side of the barricade to add target value to the barricade.

e. WARNING LIGHTS:

- 1) DESIGN: All warning lights shall meet the requirements of the MUTCD.

- 2) APPLICATION

- (a) Type A low-intensity flashing lights shall be used as shown in the Plans, the Standards, and as directed by the Engineer. Flashing lights are not required for advance warning signs in [Subsection 150.03.H](#).

- (b) Type C Steady-Burn lights shall be used as shown in the Plans, the Standards, and as directed by the Engineer. Steady-burn lights are not required on drums for merging tapers that exist into the night.

f. TEMPORARY BARRIERS

- 1) DESIGN: Temporary barriers shall meet the requirements of Sections 620.

- 2) APPLICATION: Temporary barriers shall be placed as required by the plans, standards, and as directed by the Engineer. When Temporary barrier is located 20 feet or less from a travel lane, yellow reflectors shall be fixed to the top of the barrier at intervals not greater than 40 feet in the longitudinal section and 20 feet in the taper section and shall be mounted approximately two inches above the barrier. If both lanes of a two-lane two-way roadway are within 20 feet or less of the barrier then the reflectors shall be installed for both directions of traffic.

The reflectors shall be 100 square inches (ASTM Type VII or VIII) reflective sheeting mounted on flat-sheet blanks. The reflectors shall be mounted approximately two inches above the top of the barrier. The reflectors shall be attached to the barrier with adhesive or by a drilled-in anchor type device. The reflectors shall not be attached to a post or board that is placed between the gap in the barrier sections.

Approach end of Temporary barrier shall be flared or protected by an impact attenuator (crash cushion) or other approved treatment in accordance with Construction Details/Standards and Standard Specifications.

On interstate or other controlled access highways where lane shifts or crossovers cause opposing traffic to be separated by less than 40 ft., portable barrier shall be used as a separator.

B. PORTABLE IMPACT ATTENUATORS:

1. DESCRIPTION

This work consists of the furnishing (including spare parts), installation, maintenance, relocation, reuse as required, and removal of Portable Impact Attenuator Units/Arrays.

2. MATERIALS

Materials used in the Attenuator shall meet the requirements of [Section 648](#) for Portable Impact Attenuators.

3. CONSTRUCTION

Portable Impact Attenuator Unit/Arrays installation shall conform to the requirements of [Section 648](#), Manufacturer's recommendations and Georgia Standard 4960 and shall be installed at locations designated by the Engineer, and/or as shown on the plans.

C. TEMPORARY GUARDRAIL ANCHORAGE- Type 12:

1. DESCRIPTION

This work consists of the furnishing, installation, maintenance and removal or Temporary Guardrail Anchorage- Type 12 used for Portable Barrier or temporary guardrail end treatment.

2. MATERIALS

Materials used in the Temporary Guardrail Anchorage- Type 12 shall meet the requirements of [Subsection 641.2](#) of the Specifications and current Georgia Standards and may be new or used. Materials salvaged from the Project which meet the requirements of Standards may be utilized if available. The use of any salvaged materials will require prior approval of the Engineer.

3. CONSTRUCTION

Installation of the Temporary Guardrail Anchorage- Type 12 shall conform to the requirements of the Plans, current Georgia Standards and [Subsection 641.3](#) of the Specifications. Installation shall also include sufficient additional guardrail and appurtenances to effect the transition and connection to Temporary Concrete Barrier as required by the details in Georgia Standard 4960.

150.6 DIFFERENCES IN ELEVATION BETWEEN TRAVEL LANES AND SHOULDERS (SEE [SUBSECTION 150.06.G](#) FOR PROJECTS CONSISTING PRIMARILY OF ASPHALTIC CONCRETE RESURFACING ITEMS)

Any type of work such as paving, grinding, trenching, or excavation that creates a difference in elevation between travel lanes or between the travelway and the shoulder shall not begin until the Contractor is prepared and able to continuously place the required typical section to within two inches (2") of the existing pavement elevation. For any areas that the two inches minimum difference in elevation cannot be accomplished the section shall be healed as shown in [Detail 150-E](#). If crushed stone materials are used to provide a healed section no separate payment will be made for the material used to heal any section. The Contractor may submit a plan to utilize existing pay items for crushed stone provided the plan clearly demonstrates that the materials used to heal an area will be incorporated into the work with minimal waste. Handling and hauling of any crushed stone used to heal shall be kept to a minimum. The Engineer shall determine if the crushed stone used to heal meets the specifications for gradation and quality when the material is placed in the final location.

A maximum of sixty (60) calendar days shall be allowed for conditions to exist that require any section or segment of the roadway or ramp to continue to require a healed section as described by [Detail 150-E](#). Failure to meet this requirement shall be considered as non-performance of Work under [Subsection 150.08](#).

When trenching or excavation for minor roadway or shoulder widening is required, all operations at one site shall be completed to the level of the existing pavement in the same work day.

Any channelization devices utilized in the work shall conform to the requirements of [Subsection 150.05](#) and to the placement and spacing requirements in [Details 150-B](#), [150-C](#), [150-D](#), and [150-E](#) shown in this section.

Any construction activity that reduces the width of a travel lane shall require the use of a W-20 sign with the legend "LEFT/RIGHT LANE NARROWS". Two 24" x 24" red or red/orange flags may be mounted above the W-20 sign. The W-20 sign shall be located on the side of the travelway that has been reduced in width just off the travelway edge of pavement. The W-20 sign shall be a minimum of 500 feet in advance of any channelization devices that encroach on the surface of travelway. A portable changeable message sign may be used in lieu of the W-20 sign.

GENERAL/TIME RESTRICTIONS:

A. STONE BASES, SOIL AGGREGATE BASE AND SOIL BASES

1. All Highways

Differences in elevation of more than two inches between surfaces carrying or

adjacent to traffic will not be allowed for more than a 24-hour period. A single length of excavated area that does not exceed 1000 feet in total length may be left open as a start up area for periods not to exceed 48 hours provided the Contractor can demonstrate the ability to continuously excavate and backfill in a proficient manner. Prior approval of the Engineer shall be obtained before any startup area may be allowed.

2. LIMITED ACCESS HIGHWAY RAMPS (INTERSTATES):

On projects that include ramp rehabilitation work, one ramp at a time may be excavated for the entire length of the ramp from the gore point of the ramp with the interstate mainline to the intersection with the crossing highway. This single ramp may remain excavated with a vertical difference in elevation greater than two (2") inches for a maximum of fourteen (14) calendar days with drums spaced at twenty (20') feet intervals as shown in Detail 150-B and a buffer space accepted under Section 150.06.F. After fourteen (14) calendar days the section shall be healed as required for all other highways. This area will be allowed in addition to the 1000 feet allowed for all other highways.

B. ASPHALT BASES, BINDERS AND TOPPING

1. DIFFERENCES IN ELEVATION BETWEEN THE SURFACES OF ADJACENT TRAVELWAYS

Travel lanes shall be paved with a plan that minimizes any difference in elevation between adjacent travel lanes. The following limitations will be required on all work:

- a. Differences of two inches (2") or less may remain for a maximum period of fourteen (14) calendar days.
- b. Differences of greater than two inches (2") shall be permitted for continuous operations only.

EMERGENCY SITUATIONS: Inclement weather, traffic accidents, and other events beyond the control of the Contractor may prevent the work from being completed as required above. The Contractor shall notify the Engineer in writing stating the conditions and reasons that have prevented the Contractor from complying with the time limitations. The Contractor shall also outline a plan detailing immediate steps to complete the work. Failure to correct these conditions on the first calendar day that conditions will allow corrective work shall be considered as non-performance of Work under [Subsection 150.08](#).

2. Differences in Elevation Between Asphalt Travelway and Paved Shoulders

Differences in elevation between the asphalt travelway and asphalt paved shoulders shall not be allowed to exist beyond the maximum durations outlined below for the conditions shown in [Details 150-B](#), [150-C](#), [150-D](#), and [150-E](#):

Detail 150-B conditions shall not be allowed for more than 24 hours. A single length that does not exceed 1000 feet in total length may be left open for periods not to exceed 48 hours provided the Contractor can demonstrate the ability to continuously pave in a proficient manner. Prior approval of the Engineer shall be obtained before any section is allowed to exceed 24 hours. Any other disturbed shoulder areas shall be healed as in [Detail 150-E](#).

[Detail 150-C](#) conditions will not be allowed for more than 48 hours.

[Detail 150-D](#) conditions will not be allowed for more than 30 calendar days.

[Detail 150-E](#) conditions will not be allowed for more than 60 calendar days.

Failure to meet these requirements shall be considered as non-performance of Work under [Subsection 150.08](#).

C. PORTLAND CEMENT CONCRETE

Work adjacent to a Portland Cement Concrete traveled way which involves the following types of base and shoulders shall be accomplished according to the time restrictions outlined for each type of base or shoulder. Traffic control devices shall be in accordance with [Subsection 150.05](#).

1. Cement Stabilized Base

Work adjacent to the traveled way shall be healed as per [Detail 150-E](#) within forty-eight (48) hours after the seven (7) calendar day curing period is complete for each section placed. During the placement and curing period, traffic control shall be in accordance [Detail 150-B](#).

2. Asphaltic Concrete Base

When an asphaltic concrete base is utilized in lieu of a cement stabilized base the asphaltic concrete base shall be healed as per [Detail 150-E](#) within forty-eight (48) hours after the placement of each section of asphaltic concrete base. For the first forty eight hours traffic control shall be in compliance with [Detail 150-B](#).

3. Concrete Paved Shoulders

Concrete paved shoulders shall be placed within sixty (60) calendar days after the removal of each section of existing shoulder regardless of the type of base materials being placed on the shoulders. During the placement period, traffic control devices shall be in accordance with the appropriate detail based on the depth of the change in elevation. Differences in elevation of more than two inches between the travel way and the shoulder will not be allowed for more than a 24-hour period. A single length of excavated area that does not exceed 1000 feet in total length may be left open as a start up area for periods not to exceed 48 hours provided the Contractor can demonstrate the ability to continuously excavate and backfill in a proficient manner. Prior approval of the Engineer shall be obtained before any startup area may be allowed. Any other disturbed shoulder areas shall be healed as in [Detail 150-E](#).

4. Asphaltic Concrete Shoulders

A difference in elevation that meets the requirements of [Detail 150-B](#) shall not be allowed to exist for a period greater than forty-eight (48) hours. After the removal of the existing shoulder the section or segment of travelway may be healed with stone as per [Detail 150-E](#) for a maximum of fourteen (14) calendar days. Asphaltic concrete shoulders shall be placed within two (2") inches or less of the traveled way surface within fourteen (14) calendar days after the removal of the stone healed section or the removal of each section of the existing shoulder. The two (2") inches or less difference in elevation shall not remain in existence for a period that exceeds thirty (30) calendar days unless the paved shoulder is utilized as a detour for the traveled way. During the placement period, traffic control shall be in accordance with the appropriate detail based on the depth of the change in elevation.

The Contractor may propose an alternate plan based on [Subsection 150.06.F](#). Failure to meet the above requirements and time restrictions shall be considered as non-performance of Work under [Subsection 150.08](#).

D. MISCELLANEOUS ELEVATION DIFFERENTIALS FOR EXCAVATIONS ADJACENT TO THE TRAVELWAY

Drainage structures, utility facilities, or any other work which results in a difference in elevation adjacent to the travelway shall be planned and coordinated to be performed in such a manner to minimize the time traffic is exposed to this condition. The excavation should be back filled to the minimum requirements of [Detail 150-E](#) as soon as practical. Stage construction such as plating or backfilling the incomplete work may be required. The difference in elevation shall not be allowed to exist for more than five (5) calendar days under any circumstances. Failure to correct this condition shall be considered as non-performance of Work under [Subsection 150.08](#).

E. CONDUIT INSTALLATION IN PAVED AND DIRT SHOULDERS

The installation of conduit and conduit systems along the shoulders of a traveled way shall be planned and installed in a manner to minimize the length of time that traffic is exposed to a difference in elevation condition. The following restrictions and limitations shall apply:

1. Differences in Elevation of Two (2") Inches or Less

The shoulder may remain open when workers are not present. When workers are present the shoulder shall be closed and the channelization devices shall meet the requirements of [Subsection 150.05](#). The difference in elevation on the shoulder shall remain for a maximum period of fourteen (14) calendar days.

2. Differences in Elevation Greater Than Two (2") Inches

The shoulder shall be closed. The shoulder closure shall not exceed twenty-four (24) hours in duration unless the Special Conditions in Subsection 150.11 modifies this restriction or the Engineer allows the work to be considered as a continuous operation.

Failure to meet these requirements shall be considered as non-performance of Work under [Subsection 150.08](#).

F. MODIFICATIONS TO TIME RESTRICTIONS

The Contractor may propose any alternate temporary traffic control plan that utilizes a portion of the travel lane as a "buffer space". This buffer space may allow for an enhanced work area that will allow for the placement of materials to proceed at a pace that could not be achieved with the time restriction requirements outlined in [Subsections 150.06.A, 150.06.B, and 150.06.C](#). The Contractor may propose modified time restrictions based on the use of the buffer space. Any proposed modifications in the time duration allowed for the differences in elevations to exist shall be reviewed by the Engineer as a component of the overall TTC plan. No modifications shall be made until the proposed plan is accepted by the Engineer. The Engineer shall have no obligation to consider any proposal which results in an increase in cost to the Department.

For the travel lane described in each of the [Details 150-B, 150-C, 150-D and 150-E](#) it is presumed that the pavement marking edgeline (yellow or white solid stripe) is located at the very edge of the travel lane surface. A buffer space (temporary paved shoulder) that utilizes a portion of the travel lane should be six (6') feet in width desirable but shall not be less than four (4') feet in width. Any remaining travel lane(s) shall not be less than ten (10') feet in width. Modifications to drum spacing shown in the details above will not be allowed.

If the proposed shifting of the traffic to obtain a buffer space and maintain a minimum travel lane(s) of ten (10') feet requires the use of any existing paved shoulders then the cost of maintenance and repair of the existing paved shoulder(s) shall be the responsibility of the Contractor. The Contractor is responsible for the costs of maintenance and repairs even if the existing paved shoulder(s) is to be removed in a later stage of the work. Existing shoulders that have rumble strips shall have the rumble strips removed before the shoulder can be utilized as part of the travel lane. The cost of the removal of the rumble strips shall be done at no cost to the Department even if the shoulder is to be removed in a later stage of the work.

Any modifications to the staging and time restrictions that are approved as part of the TTC plan shall be agreed to in writing. Failure to meet these modifications shall be considered as non-performance of the Work under [Subsection 150.08](#).

G. ASPHALTIC CONCRETE RESURFACING PROJECTS

SHOULDER CONSTRUCTION INCLUDED AS A PART OF THE CONTRACT: When the placement of asphaltic concrete materials creates a difference in elevation greater than two (2") inches between the earth shoulder (grassed or un-grassed) and the edge of

travelway or between the earth shoulder and a paved shoulder that is less than four (4') feet in width, the Contractor shall place and maintain drums in accordance with the requirements of [Subsection 150.05A.1.a.4](#)). When the edge of the paved surface is tapered with a 30-45 degree wedge, drums may be spaced at 2.0 times the speed limit in MPH. Drums shall remain in place and be maintained until the difference in elevation has been eliminated by the placement of the appropriate shoulder materials.

SHOULDER CONSTRUCTION NOT INCLUDED AS A PART OF THE CONTRACT: When the placement of asphaltic concrete materials creates a difference in elevation greater than two (2") inches between the earth shoulder (grassed or un-grassed) and the edge of travelway or between the earth shoulder and a paved shoulder that is less than four (4') feet in width, the Contractor shall notify the Engineer, in writing, when the resurfacing work including all punchlist items has been completed. See [Subsection 150.03.L](#) for the requirements for "LOW/SOFT SHOULDERS" and "SHOULDER DROP-OFF" signage.

| | |
|--|--|
| <p>Location of drums when Elevation Difference exceeds 4 inches. Drums spaced at 20 foot intervals.</p> <p>Note: If the travel way width is reduced to less than 10 feet by the use of drums, vertical panels shall be used in lieu of drums.</p> | |
|--|--|

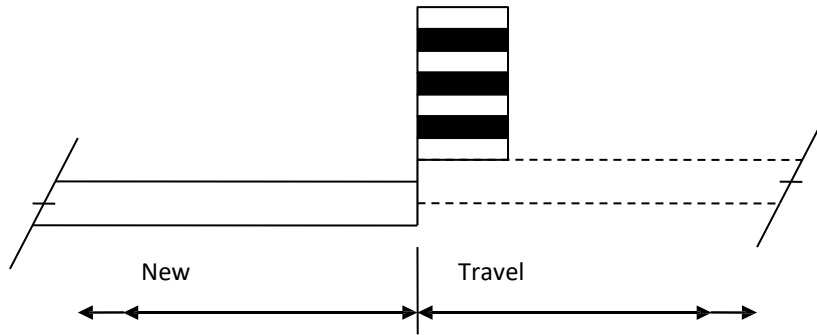

ELEVATION DIFFERENCE GREATER THAN 4 INCHES
DETAIL 150-B

| | |
|------------------------------------|---|
| Drums spaced at 40 foot intervals. | Location of drums when Elevation Difference is 2+ inches to 4 inches. |
|------------------------------------|---|

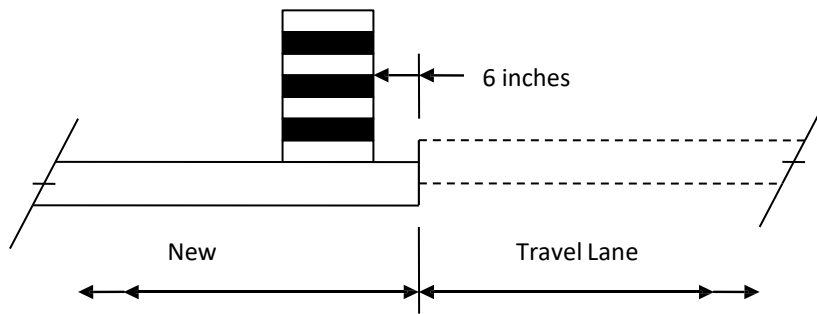

ELEVATION DIFFERENCE 2+ to 4 inches
DETAIL 150-C

Drums spaced at 80 foot intervals.

Location of drums when Elevation Difference is 2 inches or less.

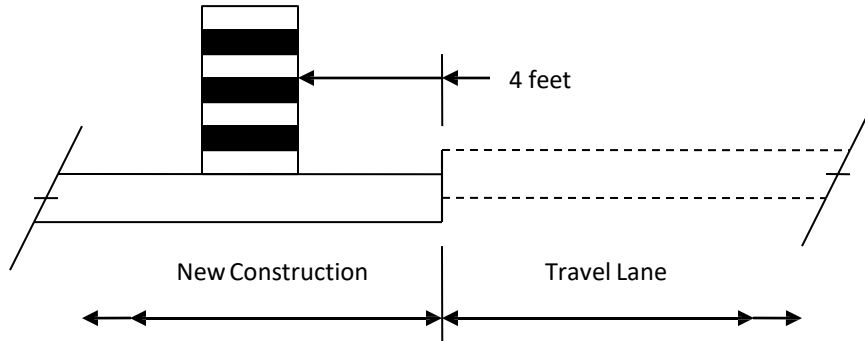

ELEVATION DIFFERENCE OF 2 INCHES OR LESS

DETAIL 150-D

Location of drums immediately after completion of healed sections spaced at 40 foot intervals.

Compacted graded aggregate,

NO STEEPER THAN 4:1

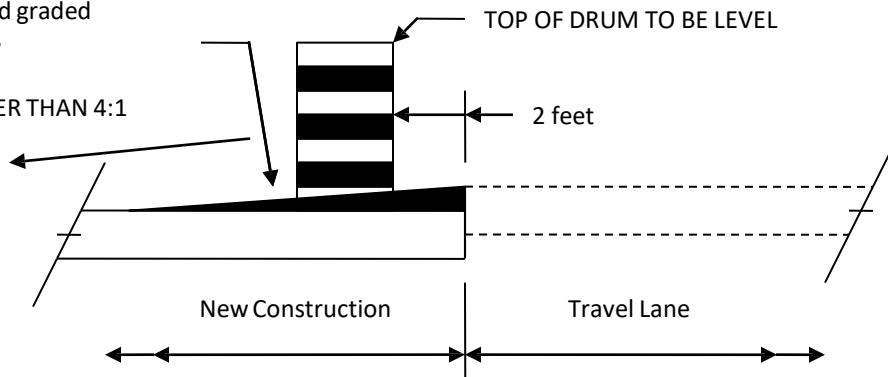

HEALED SECTION

DETAIL 150-E

150.7 FLAGGING AND PILOT CARS:

A. FLAGGERS

Flaggers shall be provided as required to handle traffic, as specified in the Plans or Special Provisions, and as required by the Engineer.

B. FLAGGER CERTIFICATION

All flaggers shall meet the requirements of the MUTCD and shall have received training and a certificate upon completion of the training from one of the following organizations:

National Safety Council
Southern Safety Services
Construction Safety
Consultants Ivey Consultants
American Traffic Safety Services Association (ATSSA)

Certifications from other agencies will be accepted only if their training program has been approved by any one of the organizations listed above.

Failure to provide certified flaggers as required above shall be reason for the Engineer suspending work involving the flagger(s) until the Contractor provides the certified flagger(s). Flaggers shall have proof of certification and valid identification (photo I.D.) available any time they are performing flagger duties.

C. FLAGGER APPEARANCE AND EQUIPMENT

Flaggers shall wear high-visibility clothing in compliance with [Subsection 150.01.A](#). The apparel background (outer) material color shall be fluorescent orange-red, fluorescent yellow-green, or a combination of the two as defined in the ANSI standard. The retroreflective material shall be orange, yellow, white, silver, yellow-green, or a fluorescent version of these colors, and shall be visible at a minimum distance of one thousand (1000) feet. The retroreflective safety apparel shall be designed to clearly identify the wearer as a person. They shall use a Stop/Slow paddle meeting the requirements of the MUTCD for controlling traffic. The Stop/Slow paddles shall have a shaft length of seven (7) feet minimum. The Stop/Slow paddle shall be retro-reflectorized for both day and night usage. In addition to the Stop/Slow paddle, a flagger may use a flag as an additional device to attract attention. This flag shall meet the minimum requirements of the MUTCD. The flag shall, as a minimum, be 24" inches square and red or red/orange in color. For night work, the vest shall have reflectorized stripes which meet the requirements of the MUTCD.

D. FLAGGER WARNING SIGNS

Signs for flagger traffic control shall be placed in advance of the flagging operation in accordance with the MUTCD. In addition to the signs required by the MUTCD, signs at regular intervals, warning of the presence of the flagger

shall be placed beyond the point where traffic can reasonably be expected to stop under the most severe conditions for that day's work.

E. PILOT VEHICLE REQUIREMENTS

Pilot vehicles will be required during placement of bituminous surface treatment or asphaltic concrete on two-lane roadways unless otherwise specified. Pilot vehicles shall meet the requirements of the MUTCD.

F. PORTABLE TEMPORARY TRAFFIC CONTROL SIGNALS

The Contractor may request, in writing, the substitution of portable temporary traffic control signals for flaggers on two-lane two-way roadways provided the temporary signals meets the requirements of the MUTCD, [Section 647](#), and [Subsection 150.02.A.8](#). As a part of this request, the Contractor shall also submit an alternate temporary traffic control plan in the event of a failure of the signals. Any alternate plan that requires the use of flaggers shall include the use of certified flaggers. The Contractor shall obtain the approval of the Engineer before the use of any portable temporary traffic control signals will be permitted.

150.8 ENFORCEMENT

The safe passage of pedestrians and traffic through and around the temporary traffic control zone, while minimizing confusion and disruption to traffic flow, shall have priority over all other Contractor activities. Continued failure of the Contractor to comply with the requirements of Section 150 (TRAFFIC CONTROL) will result in non-refundable deductions of monies from the Contract as shown in this Subsection for non-performance of Work.

Failure of the Contractor to comply with this Specification shall be reason for the Engineer suspending all other work on the Project, except erosion control and traffic control, taking corrective action as specified in [Subsection 105.15](#), and/or withholding payment of monies due to the Contractor for any work on the Project until traffic control deficiencies are corrected. These other actions shall be in addition to the deductions for non-performance of traffic control.

| SCHEDULE OF DEDUCTIONS FOR EACH CALENDAR DAY OF DEFICIENCIES OF TRAFFIC CONTROL INSTALLATION AND/OR MAINTENANCE | | |
|--|------------------|--------------|
| ORIGINAL TOTAL CONTRACT AMOUNT | | |
| From More Than | To and Including | Daily Charge |
| \$0 | \$100,000 | \$200 |
| \$100,000 | \$1,000,000 | \$500 |
| \$1,000,000 | \$5,000,000 | \$1,000 |
| \$5,000,000 | \$20,000,000 | \$1,500 |
| \$20,000,000 | \$40,000,000 | \$2,000 |
| \$40,000,000 | \$----- | \$3,000 |

150.9 MEASUREMENT

A. TRAFFIC CONTROL

When listed as a pay item in the Proposal, payment will be made at the Lump Sum price bid, which will include all traffic control not paid for separately, and will be paid as follows:

When the first Construction Report is submitted, a payment of 25 (twenty-five) percent of the Lump Sum price will be made. For each progress payment thereafter, the total of the Project percent complete shown on the last pay statement plus 25 (twenty-five) percent will be paid (less previous payments), not to exceed one hundred (100) percent.

When no payment item for *Traffic Control-Lump Sum* is shown in the Proposal, all of the requirements of Section 150 and the Temporary Traffic Control Plan shall be in full force and effect. The cost of complying with these requirements will not be paid for separately, but shall be included in the overall bid submittal.

B. SIGNS

When shown as a pay item in the contract, interim special guide signs will be paid for as listed below. All other regulatory, warning, and guide signs, as required by the Contract, will be paid for under Traffic Control Lump Sum or included in the overall bid submitted.

1. Interim ground mounted or interim overhead special guide signs will be measured for payment by the square foot. This payment shall be full compensation for furnishing the signs, including supports as required, erecting illuminating overhead signs, maintaining, removing, re-erecting, and final removal from the Project. Payment will be made only one time regardless of the number of moves required.
2. Remove and reset existing special guide signs, ground mount or overhead, complete, in

place, will be measured for payment per each. Payment will be made only one time regardless of the number of moves required.

3. Modify special guide signs, ground mount or overhead, will be measured for payment by the square foot. The area measured shall include only that portion of the sign modified. Payment shall include materials, removal from posts or supports when necessary, and remounting as required.

C. TEMPORARY BARRIER

Temporary Barrier shall be measured as specified in [Section 622](#).

D. CHANGEABLE MESSAGE SIGN, PORTABLE

Changeable Message Sign, Portable will be measured as specified in [Section 632](#).

E. TEMPORARY GUARDRAIL ANCHORAGE, Type 12

Temporary Guardrail Anchorage- Type 12 will be measured by each assembly, complete in place and accepted according to the details shown in the plans, which shall also include the additional guardrail and appurtenances necessary for transition and connection to Temporary Concrete Barrier. Payment shall include all necessary materials, equipment, labor, site preparation, maintenance and removal.

F. TRAFFIC SIGNAL INSTALLATION- TEMPORARY

Traffic Signal Installation- Temporary will be measured as specified in [Section 647](#).

G. FLASHING BEACON ASSEMBLY

Flashing Beacon Assemblies will be measured as specified in [Section 647](#).

H. PORTABLE IMPACT ATTENUATORS

Each Portable Impact Attenuator will be measured by the unit/array which shall include all material components, hardware, incidentals, labor, site preparation, and maintenance, including spare parts recommended by the manufacturer for repairing accident damage. Each unit will be measured only once regardless of the number of locations installed, moves required, or number of repairs necessary because of traffic damage. Upon completion of the project, the units shall be removed and retained by the Contractor.

I. PAVEMENT MARKINGS

Pavement markings will be measured as specified in Section 150.

J. TEMPORARY WALKWAYS WITH DETECTABLE EDGING

Temporary walkways with detectable edging will be measured in linear feet (meters), complete in place and accepted, which shall include all necessary materials, equipment, labor, site preparation, temporary pipes, passing spaces, maintenance and removal. Excavation and backfill are not measured separately for payment. No payment will be made for temporary walkways where existing pavements or existing edging (that meets the requirements of

MUTCD) are utilized for the temporary walkway. Payment for temporary detectable edging, including approved barriers and channelizing devices, installed on existing pavement shall be included in Traffic Control-Lump Sum.

K. TEMPORARY CURB CUT WHEELCHAIR RAMPS

Temporary curb cut wheelchair ramps are measured as the actual number formed and poured, complete and accepted, which shall include all necessary materials, equipment, labor, site preparation, maintenance and removal. No additional payment will be made for sawing existing sidewalk and removal and disposal of removed material for temporary wheelchair ramp construction. No additional payment will be made for constructing the detectable warning surface.

L. TEMPORARY AUDIBLE INFORMATION DEVICE

Temporary audible information devices are measured as the actual number furnished and installed in accordance with the manufacturer’s recommendations, which shall include all necessary materials, equipment, labor, site preparation, maintenance and removal. Each temporary audible information device will be paid for only one time regardless of the number of times it’s reused during the duration of The Work. These devices shall remain the property of the Contractor.

150.10 PAYMENT:

When shown in the Schedule of Items in the Bid, the following items will be paid for separately.

| | |
|--|-----------------|
| Item No. 150 Traffic Control..... | Lump Sum |
| Item No. 150 Traffic Control, Solid Traffic Stripe_Inch, (Color)..... | per Linear Mile |
| Item No. 150 Traffic Control, Skip Traffic Stripe_Inch, (Color)..... | per Linear Mile |
| Item No. 150 Traffic Control, Solid Traffic Stripe, Thermoplastic_Inch, (Color)..... | per Linear Mile |
| Item No. 150 Traffic Control, Skip Traffic Stripe, Thermoplastic_Inch, (Color)..... | per Linear Mile |
| Item No. 150 Traffic Control, Pavement Arrow with Raised Reflectors..... | per Each Item |
| Item No. 150 Traffic Control, Raised Pavement Markers-All Types..... | per Each Item |
| Item No. 150 Interim Ground Mounted Special Guide Signs..... | per Square Foot |
| Item No. 150 Interim Overhead Special Guide Signs..... | per Square Foot |
| Item No. 150 Remove & Reset Existing Special Guide Signs, Ground Mount, Complete in Place..... | per Each |
| Item No. 150 Remove & Reset Existing Special Guide Signs, Overhead, Complete in Place..... | per Each |
| Item No. 150 Traffic Control, Portable Impact Attenuator..... | per Each |
| Item No. 150 Traffic Control, Pavement Markers, Words and Symbols..... | per Square Foot |
| Item No. 150 Traffic Control, Pavement Arrow (Painted) with Raised Reflectors..... | per Each |
| Item No. 150 Traffic Control, Workzone Law Enforcement..... | per Hour |
| Item No. 150 Modify Special Guide Sign, Ground Mount..... | per Square Foot |
| Item No. 150 Modify Special Guide Sign, Overhead..... | per Square Foot |
| Item No. 150 Temporary Walkways with Detectable Edging..... | per Linear Foot |
| Item No. 150 Temporary Curb Cut Wheelchair Ramps..... | per Each |
| Item No. 150 Temporary Audible Information Device..... | per Each |
| Item No. 620 Temporary Barrier..... | per Linear Foot |
| Item No. 632 Changeable Message Sign, Portable..... | per Each |
| Item No. 641 Temporary Guardrail Anchorage, Type 12..... | per Each |

Item No. 647 Traffic Signal Installation, Temp.....per Lump Sum
Item No. 647 Flashing Beacon Assembly, Structure Mounted.....per Each
Item No. 647 Flashing Beacon Assembly, Cable Supported.....per Each

150.11 Special Conditions:

- A. Lane closures will not be permitted during weekdays (Monday through Friday) between the hours of 5:00 a.m. to 9:00 a.m.; and 4:00 p.m. to 7:00 p.m. Monday through Friday. Contractor shall not install lane closures or move equipment or materials on the traveled way outside of these working hours. Work hours for this project shall be as follows: 7:30 a.m. to 8:30 p.m. Monday through Friday, 8:00 a.m. to 5:00 p.m. Saturday (with prior approval from the Engineer), no work to be performed Sunday. Failure of the Contractor to comply with this specification will result in Liquidated Damages as specified in Subsection 108.08.

- B. A TRAFFIC CONTROL PLAN SHALL BE SUBMITTED TWO (2) WEEKS PRIOR TO ANY WORK FOR REVIEW AND APPROVAL BY THE ENGINEER.

- C. No work shall be allowed during the following dates due to holidays:
 - May 27, 2019 - Memorial Day
 - July 4, 2019 - 4th of July
 - September 2, 2019 - Labor Day
 - November 11, 2019- Veterans Day
 - November 28, 2019 - November 29, 2019 - Thanksgiving
 - December 24-25, 2019 and January 1, 2020 - Christmas and New Years

- D. Lane closures shall not be allowed during the weekends of the Georgia Tax Free Weekends.

- E. For this project, the Contractor shall ensure that all final grading and completed construction of all proposed curb and gutter, guardrail, sidewalk, striping, driveway reconstruction and wall construction work associated with the project be complete and shall be open to traffic within 90 days. Failure of the Contractor to comply with this specification will result in Liquidated Damages as specified in Subsection 108.08.

- F. The contractor shall provide work zone law enforcement during the mill and inlay activities as directed by the Engineer and shall be included in the bid price for Section 150 – Traffic Control. Failure of the Contractor to comply with this specification will result in Liquidated Damages as specified in Subsection 108.08.

- G. Maintenance of Existing Traffic Signals and Detection Devices: Presence detection shall be maintained, including but not limited to installation of additional presence detection material and equipment required for staged construction. This work will be included in the overall bid price submitted for Traffic Control. Failure of the Contractor to comply with this specification will result in non-refundable deductions as specified in accordance with 150.08.

- H. For this project, changeable message signs shall be provided as needed by the Contractor during the week preceding and through the duration of the contract. The contractor shall maintain messages on all message boards 24 hours a day during that period or as directed by the Engineer. Failure to respond to the direction of the Engineer within 2 hours shall result in the assessment of Liquidated Damages as specified in

Subsection 108.08. The cost of these message boards and all work incidental to their placement and operation shall be included in the bid price for Section 150 – Traffic Control.

I. ITS SYSTEM:

1. The ITS System within the project limits and all those portions outside of the Project limits needed for temporary and permanent signing shall not be taken out of service for more than 24 hours at any time during construction.
2. Within 24 hours the Contractor shall repair any existing components of the ITS System that are damaged as a result of performing The Work at no cost to the City.

Failure to restore system functionality within the time specified will result in the assessment of Liquidated Damages as specified in Special Provision 108.08.

CITY OF BROOKHAVEN
DEPARTMENT OF PUBLIC WORKS
SPECIAL PROVISION
PROJECT: 2019 Resurfacing & Reconstruction

Modifications of the GDOT Standard Specifications, 2013 Edition

Section 161—Control of Soil Erosion and Sedimentation

Add the following:

161.1 General Description

This Work includes using control measures shown on the Plans, ordered by the Engineer, or as required during the life of the Contract to control soil erosion and sedimentation through the use of any of the devices or methods referred to in this Section.

161.1.01 Definitions

Certified Personnel— certified personnel are defined as persons who have successfully completed the Level IA certification course approved by the Georgia Soil and Water Conservation Commission. For Department projects the certified person must also have successfully completed the Department’s WECS certification course.

Design Professional as defined in the current GAR100002 NPDES permit.

161.1.02 Related References

A. Standard Specifications [Section](#)

[105—Control of Work Section](#)

[106—Control of Materials](#)

[Section 107—Legal Regulations and Responsibility to the Public](#)

[Section 109—Measurement and Payment](#)

[Section 160—Reclamation of Material Pits and Waste Areas](#)

[Section 162—Erosion Control Check Dams](#)

[Section 163—Miscellaneous Erosion Control Items](#)

[Section 166—Restoration or Alteration of Lakes and Ponds](#)

[Section 170—Silt Retention Barrier](#)

[Section 171—Temporary Silt Fence](#)

[Section 205—Roadway Excavation](#)

[Section 434—Sand Asphalt Paved Ditches](#)

[Section 441—Miscellaneous Concrete](#)

[Section 603—Rip Rap](#)

[Section 700—Grassing](#)

[Section 710—Permanent Soil Reinforcing Mat](#)

[Section 715—Bituminous Treated Roving](#)

[Section 716—Erosion Control Mats \(Blankets\)](#)

Erosion control measures contained in the Specifications include:

| Erosion Control Measure | Section |
|--|---|
| Temporary Check Dams | 163.3.05.J |
| Bituminous Treated Mulch | 700.3.05.G |
| Concrete Paved Ditches | 441 |
| Bituminous Treated Roving | 715 |
| Erosion Control Mats (Blankets) | 716 |
| Erosion Control Check Dams | 162 |
| Grassing | 700 |
| Maintenance of Temporary Erosion Control Devices | 165 |
| Permanent Soil Reinforcing Mat | 710 |
| Reclamation of Material Pits and Waste Areas | 160 |
| Rip Rap | 603 |
| Restoration or Alteration of Lakes and Ponds | 166 |
| Sand-Asphalt Ditch Paving | 434 |
| Sediment Basin | 163.3.05.C |
| Silt Control Gate | 163.3.05.A |
| Silt Retention Barrier | 170 |
| Sod | 700.3.05.H & 700.3.05.I |
| Mulch | 163 |
| Temporary Grassing | 163.3.05.F |
| Temporary Silt Fence | 171 |
| Temporary Slope Drains | 163.3.05.B |
| Triangular Sediment Barrier | 720 |
| Silt Filter Bag | 719 |
| Organic & Synthetic Material Fiber Blanket | 713 |

B. Referenced Documents

Erosion and Sedimentation Pollution Control Plans (ESPCP)

161.1.03 Submittals

A. Status of Erosion Control Devices

The Worksite Erosion Control Supervisor (WECS) or certified personnel will inspect the installation and maintenance of the Erosion Control Devices according to [Subsection 167.3.05.B](#) and the ESPCP.

1. Submit all reports to the Engineer within 24 hours of the inspection. Refer to [Subsection 167.3.05.C](#) for report requirements.
2. The Engineer will review the reports and inspect the Project for compliance and concurrence with the submitted reports.
3. The Engineer will notify the WECS or certified personnel of any additional items that should be added to the reports.
4. Items listed in the report requiring maintenance or correction shall be completed within 72 hours.

B. Erosion and Sedimentation Pollution Control Plan

1. Project Plans

An erosion and sedimentation pollution control plan (ESPCP) for the construction of the project will be provided by the Department. The ESPCP will be prepared for the various stages of construction necessary to complete the project. If the Contractor elects to alter the stage construction from that shown in the plans, it will be the responsibility of the Contractor to have the plans revised and prepared in accordance with the current GAR100002 NPDES permit by a Design Professional to reflect all changes in Staging. This will also include any revisions to erosion and sedimentation control item quantities. If the changes affect the Comprehensive Monitoring Program (CMP), the Contractor will be responsible for any revisions to the CMP as well. Submit revised plans and quantities to the Engineer for review prior to land disturbing activities.

2. Haul Roads, Borrow Pits, Excess Material Pits, etc.

The Contractor is responsible for preparing erosion and sedimentation control plans for construction access roads and or haul roads borrow pits, excess material pits, etc (inside the Right of Way). Prepare these plans for all stages of construction and include the appropriate items and quantities. Submit these plans to the Engineer for review prior to land disturbing activities. These plans are to be prepared by a Design Professional.

If construction of access roads, haul roads, borrow pits, excess material pits, etc., (inside the Right of Way) encroach within the 25 foot (7.6 m) buffer along the banks of all state waters or within the 50 ft. (15 m) buffer along the banks of any state waters classified as a "trout stream", a state water buffer variance must be obtained by the Contractor prior to beginning any land disturbing activity in the stream buffer.

3. Erosion Control for Borrow and Excess Material Pits Outside the Right-of-Way

Erosion control for borrow pits and excess material pits outside the right of way is the responsibility of the Contractor. If borrow or excess material pits require coverage under the National Pollutant Discharge Elimination System permit (NPDES) or other permits or variances are required, submit a copy of all documentation required by the permitting agency to the Engineer. All costs associated with complying with local, state, and federal laws and regulations are the responsibility of the Contractor.

4. Culverts and Pipes

The ESPCP does not contain approved methods to construct a stream diversion or stream diversion channel. The Contractor shall prepare a diversion plan utilizing a Design Professional as defined in the current NPDES permit. See [Subsection 161.3.05 G](#) for additional information.

5. Temporary Asphalt or Concrete Batch Plants

In addition to the requirements of any applicable specifications, if the Department authorizes the temporary installation and use of any asphalt, concrete or similar batch plants within its right of way, the contractor shall submit an NOI to the Georgia Environmental Protection Division for coverage under the following NPDES permits; The Infrastructure permit for the construction of the plant, and the Industrial permit for the operation of, such a plant. The contractor shall submit the NOIs as both the Owner and the Operator.

161.2 Materials

General Provisions 101 through 150.

161.2.01 Delivery, Storage, and Handling

General Provisions 101 through 150.

161.3 Construction Requirements

161.3.01 Personnel

A. Duties of the Worksite Erosion Control Supervisor

Before beginning Work, designate a Worksite Erosion Control Supervisor (WECS) to initiate, install, maintain, inspect, and report the condition of all erosion control devices as described in Sections 160 through 171 or in the Contract and ESPCP documents. The designee shall submit their qualifications on the Department provided resume form for consideration and approval. The contractor may utilize additional persons having WECS qualifications to facilitate compliance however, only one WECS shall be designated at a time.

The WECS and alternates shall:

- Be an employee of the Prime Contractor.
- Have at least one year of experience in erosion and sediment control, including the installation, inspection, maintenance and reporting of BMPs.
- Successfully completed the Georgia Soil and Water Conservation Commission Certification Course Level IA and the Department's WECS Certification Course.
- Provide phone numbers where the WECS can be located 24 hours a day.

The WECS' duties include the following:

1. Be available or have an approved representative available 24 hours a day and have access to the equipment, personnel, and materials needed to maintain erosion control and flooding control.
2. Inform the Engineer in writing whenever the alternate WECS assumes project responsibilities.
3. Ensure that erosion control deficiencies are corrected within seventy two (72) hours or immediately during emergencies. Deficiencies that interfere with traffic flow, safety or downstream turbidity are to be corrected immediately.
4. During heavy rain, have the construction area patrolled day or night, any day of the week to quickly detect and correct erosion or flooding problems before they interfere with traffic flow, safety, or downstream turbidity.
5. Be on the site within three (3) hours after receiving notification of an emergency prepared to positively respond to the conditions encountered. The Department may handle emergencies without notifying the Contractor. The Department will recover costs for emergency maintenance work according to [Subsection 105.15, "Failure to Maintain Roadway or Structures."](#)
6. Maintain and submit for project record, "As-built" Erosion and Sedimentation Control Plans that supplement and graphically depict EC-1 reported additions and deletions of BMPs. The As-Built plans are to be accessed and retained at a Department facility at all times.
7. Ensure that both the WECS and the alternate meet the criteria of this Subsection.
8. The WECS shall maintain a current certification card for the duration of the project. Recertification of the WECS will be required prior to the expiration date shown on the Certification card in order to remain as Certified Personnel and the WECS for the project.

Failure of the WECS or alternate to perform the duties specified in the Contract, or whose performance, has resulted in a citation being received from a State or Federal Regulatory Agency, e.g. the Georgia Environmental Protection Division, shall result in one or more of the following;

- Suspension of the WECS' certification for a period of not less than 30 days
- Removal of the Contractor's project superintendent in accordance with [Subsections 105.05](#) and [108.05](#) for a period not less than 14 days
- Department wide revocation of the WECS certification for a period of 12 months
- Removal of the Contractor's project superintendent in accordance with [Subsections 105.05](#) and [108.05](#)

161.3.02 Equipment

General Provisions 101 through 150.

161.3.03 Preparation

General Provisions 101 through 150.

161.3.04 Fabrication

General Provisions 101 through 150.

161.3.05 Construction

Coordinate the temporary and permanent erosion control provisions in this Specification with the permanent erosion control

provisions in the Contract to ensure economical, effective, and continuous erosion control throughout the construction and post-construction periods.

At all times that land disturbing activity is underway, a person meeting the requirements of, “certified person” by the GSWCC (Level IA) must be on the project.

A. Control Dust Pollution

The contractor shall keep dust pollution to a minimum during any of the activities performed on the project. It may be necessary to apply water or other BMPs to roadways or other areas reduce pollution.

B. Perform Permanent or Temporary Grassing

Perform permanent grassing, temporary grassing, or mulching on cut and fill slopes weekly (unless a shorter period is required by [Subsection 107.23](#)) during grading operations. When conditions warrant, the Engineer may require more frequent intervals.

Under no circumstances shall the grading (height of cut) exceed the height operating range of the grassing equipment. It is extremely important to obtain a cover, whether it is mulch, temporary grass or permanent grass. Adequate mulch is a must.

When grading operations or other soil disturbing activities have stopped, perform grassing or erosion control as shown in the Plans, as shown in an approved Plan submitted by the Contractor, or as directed by the Engineer.

C. Seed and Mulch

Refer to [Subsection 161.3.05.B, “Perform Permanent or Temporary Grassing ”](#).

D. Implement Permanent or Temporary Erosion Control

1. Silt fence shown along the perimeter, e.g. right of way, and sediment containment devices, e.g. sediment basins, shall be installed prior to or concurrently with clearing and grubbing operations.
2. Incorporate permanent erosion control features into the Project at the earliest practicable time, e.g. velocity dissipation, permanent ditch protection.
3. Use temporary erosion control measures to address conditions that develop during construction but were unforeseen during the design stage.
4. Use temporary erosion control measures when installation of permanent erosion control features cannot be accomplished.

The Engineer has the authority to:

- Limit the surface area of erodible earth material exposed by clearing and grubbing.
- Limit the surface area of erodible earth material exposed by excavation and borrow and fill operations.
- Limit the area of excavation, and embankment operations in progress to correspond with the Contractor’s ability to keep the finish grading, mulching, seeding, and other permanent erosion control measures current.
- Direct the Contractor to provide immediate permanent or temporary erosion control to prevent contamination of adjacent streams or water courses, lakes, ponds, or other areas of water impoundment.

Such Work may include constructing items listed in the table in [Subsection 161.1.02.A, “Related Refer ences”](#) or other control devices or methods to control erosion.

E. Erodible Area

NOTE: Never allow the surface area of erodible earth material exposed at one time to exceed 17 acres (7 ha) except as approved by the State Construction Engineer.

The maximum of 17 acres (7 ha) of exposed erodible earth applies to the entire Project and to all of its combined operations as a whole, not to the exposed erodible earth of each individual operation.

Upon receipt of a written request from the contractor the State Construction Engineer, or his designee, will review; the request, any justifications and the Project conditions for waiver of the 17 acres (7 ha) limitation.

If the 17 acre limitation is increased by the State Construction Engineer, the WECS shall not be assigned to another project in that capacity and should remain on site each work day that the exposed acreage exceeds 17 acres.

After installing temporary erosion control devices, e.g., grassing, mulching, stabilizing an area, and having it approved by the

Engineer, that area will be released from the 17 acres (7 ha) limit.

F. Perform Grading Operations

Perform the following grading operations:

1. Complete each roadway cut and embankment continuously, unless otherwise specified in the Contract or ordered by the Engineer.
2. Maintain the top of the earthwork in roadway sections throughout the construction stages to allow water to run off to the outer edges.
3. Provide temporary slope drain facilities with inlets and velocity dissipaters (straw bales, silt fence, aprons, etc.) to carry the runoff water to the bottom of the slopes. Place drains at intervals to handle the accumulated water.
4. Continue temporary erosion control measures until permanent drainage facilities have been constructed, pavement placed, and the grass on planted slopes stabilized to deter erosion.

G. Perform Construction in Rivers and Streams

Perform construction in river and stream beds as follows:

1. Unless otherwise agreed to in writing by the Engineer, restrict construction operations in rivers, streams, and impoundments to:
 - Areas where channel changes or access for construction are shown on the Plans to construct temporary or permanent structures.
2. If channel changes or diversions are not shown on the Plans, the Contractor shall develop diversion plans prepared in accordance with the current GAR100002 NPDES Infrastructure Construction permit utilizing a design professional as defined within the permit. The Engineer will review prepared diversion plans for content only and accepts no responsibility for design errors or omissions. Amendments will be made part of the project plans by attachment. Include any associated costs in the price bid for the overall contract. Any contract time associated with the submittal or its review and subsequent response will not be considered for an extension of Contract time. All time associated with this subsection shall be considered incidental.
3. If additional access for construction or removal of work bridges, temporary roads/access or work platforms is necessary, and will require additional encroachment upon river or stream banks and bottoms, the contractor shall prepare a plan in accordance with the current GAR100002 NPDES Infrastructure Construction permit utilizing a design professional as defined within the permit. Plans should be submitted at least 12 weeks prior to the date the associated work is expected to begin. If necessary, the plan will be provided to the appropriate regulating authority, e.g. United States Army Corps of Engineers by the Department for consideration and approval. No work that impacts areas beyond what has been shown in the approved plans will be allowed to begin until written approval of the submitted plan has been provided by the Department. Approved plan amendments will be made part of the project plans by attachment. Include any associated costs in the price bid for the overall contract. Any contract time associated with the submittal or its review and subsequent response will not be considered for an extension of Contract time. All time associated with this subsection shall be considered incidental.
4. Clear rivers, streams, and impoundments of the following as soon as conditions permit:
 - Falsework
 - Piling that is to be removed
 - Debris
 - Other obstructions placed or caused by construction operations
5. Do not ford live streams with construction equipment.
6. Use temporary bridges or other structures that are adequate for a 25-year storm for stream crossings. Include costs in the price bid for the overall contract.
7. Do not operate mechanized equipment in live streams except to construct channel changes or temporary or permanent structures, and to remove temporary structures, unless otherwise approved in writing by the Engineer.

H. State Water Buffers and Environmental Restrictions

- 1 The WECS shall review the plans and contract documents for environmental restrictions, Environmentally Sensitive Areas

(ESA), e.g. buffers, etc prior to performing land disturbing activities.

2. The WECS shall ensure all parties performing land disturbing activities within the project limits are aware of all environmental restrictions.
3. Buffer delineation shall be performed prior to clearing, or any other land disturbing activities. Site conditions may require temporary delineation measures are implemented prior to the installation of orange barrier/safety fencing. The means of temporary delineation shall have the Engineer's prior approval.
4. The WECS shall allow the Engineer to review the buffer delineation prior to performing any land disturbing activities, including but not limited to clearing, grubbing and thinning of vegetation. Any removal and relocation of buffer delineation based upon the Engineer's review will not be measured for separate payment.
5. The WECS shall advise the Engineer of any surface water(s) encountered that are not shown in the plans. The WECS shall prevent land disturbing activities from occurring within surface water buffers until the Engineer provides approval to proceed.

I. General Requirements

Projects that consist of asphalt resurfacing, shoulder reconstruction and/or shoulder widening; schedule and perform the construction of the project to comply with the following:

After temporary and permanent erosion control devices are installed and the area permanently stabilized (temporary or permanent) and approved by the Engineer, the area may be released from the 1 acre (0.4 ha) limit.

The maximum of 1 acre (0.4 ha) of erodible earth applies to the entire project and to all combined operations, including borrow and excess material operations that are within the right of way, not 1 acre (0.4 ha) of exposed erodible earth for each operation.

NOTE: Never allow the surface area of erodible earth material exposed at one time to exceed 1 acre (0.4 ha).

1. Do not allow the disturbed exposed erodible area to exceed 1 acres (0.4 ha). This 1 acre (0.4 ha) limit includes all disturbed areas relating to the construction of the project including but not limited to slope and shoulder construction.
2. At the end of each working day, permanently stabilize all of the area disturbed by slope and shoulder reconstruction to prevent any contamination of adjacent streams or other watercourses, lakes, ponds or other areas of water impoundment. For purposes of this Specification, the end of the working day is defined as when the construction operations cease. For example, 6:00 a.m. is the end of the working day on a project that allows work only between 9:00 p.m. and 6:00 a.m.)
3. Stabilize the cut and fill slopes and shoulder with permanent or temporary grassing and a Wood Fiber Blanket ([Section 713](#), Type II). Mulching is not allowed. Borrow pits, soil disposal sites and haul roads will not require daily applications of wood fiber blanket. The application rate for the Wood Fiber Blanket on shoulder reconstruction is the rate specified for Shoulders. For shoulder reconstruction, the ground preparation requirements of [Subsection 700.3.05.A.1](#) are waived. Preparation consists of scarifying the existing shoulders 4 to 6 in (100 to 150 mm) deep and leaving the area in a smooth uniform condition free from stones, lumps, roots or other material.
4. If a sudden rain event occurs that would not allow the Contractor to apply the Type II Wood Fiber Blanket per [Section 713](#), install Wood Fiber Blanket Type I per [Section 713](#) if directed by the Engineer. Wood Fiber Blanket Type I application is for emergency use only.

Install temporary grass or permanent grass according to seasonal limitations and Specifications. When temporary grass is used, use the overseeding method ([Subsection 700.3.05.E.4](#)) when planting permanent grass.

3. Remove and dispose of all material excavated for the trench widening operation at an approved soil disposal site by the end of each working day. When shoulder reconstruction is required, this material may be used to reconstruct the graded shoulder after all asphaltic concrete pavement has been placed.
4. Provide immediate permanent and/or temporary erosion control measures for borrow pits, soil disposal sites and haul roads to prevent any contamination of adjacent streams or other watercourses, lakes, ponds or other areas of water impoundment.
5. Place asphalt in the trench the same day as the excavation occurs. Place asphalt or concrete in driveways and side roads being re-graded the same day as the excavation occurs. Stabilize any disturbed or exposed soil that is not covered with asphalt with a Wood Fiber Blanket (and grass seed). Payment will be made for the Wood Fiber Blanket and grass seed only if the shoulder has been constructed to final dimensions and grade and no further grading will be required.
6. Do not allow the grading (height of cut or fill) to exceed the operating range of the grassing equipment.
7. When grading operations or other soil disturbing activities are suspended, regardless of the reason, promptly perform all necessary permanent stabilization and/or erosion control work.
8. Use temporary erosion control measures to:
 - To correct conditions that develop during construction but were unforeseen during the design stage.
 - To use as needed before installing permanent erosion control features.
 - To temporarily control erosion that develops during normal construction practices but are not associated with permanent control features on the Project.
9. When conditions warrant, such as unfavorable weather (rain event), the Engineer may require more frequent intervals for this work.

161.3.06 Quality Acceptance

Before Final Acceptance of the Work, clean drainage structures within the project limits, both existing and newly constructed, and ensure that they are functioning properly. Costs to accomplish this work are incidental and shall be included in the overall bid for the Contract.

161.3.07 Contractor Warranty and Maintenance

Maintain the erosion control features installed to:

- Contain erosion within the limits of the right-of-way
-

Control storm water discharges from disturbed areas

Effectively install and maintain the erosion control features. Ensure these features contain the erosion and sediment within the limits of the rights of way and control the discharges of storm-water from disturbed areas to meet all local, state, and federal requirements on water quality.

If a construction Project has separate contractors, the Prime Contractor shall maintain the erosion control features at grading sites as acceptable to the Engineer until the Contract is accepted. If any erosion control devices are damaged by any contractor either by neglect, by construction methods, or any other reasons, including acts of nature, they shall be repaired within 24 hours by the Prime Contractor at no cost to the Department.

161.4 Measurement

Control of soil erosion and sedimentation is not measured separately for payment.

161.4.01 Limits

General Provisions 101 through 150.

161.5 Payment

When no pay item is shown in the Contract, the requirements of this Specification and the Erosion Control Plan shall be in full effect. The cost of complying with these requirements will not be paid for separately, but shall be included in the overall bid submitted with the exception of inspections performed by qualified personnel which will be included in Section 167.

When listed as a pay item in the Contract, payment will be made at the unit price bid for each particular item. No payment will be made for erosion control outside the Right-of-Way or construction easements except as provided for by the Plans.

161.5.01 Enforcement and Adjustments

A. Failure to Provide a WECS

If a designated WECS is not maintained or if the Contractor does not comply with this Specification, cease activities except traffic control and erosion control work. Monies that are due or that may become due also may be withheld according to the Specifications

B. Failure to submit reports

A non-refundable deduction will be taken from the schedule below whenever the WECS fails to submit completed reports required by [Subsection 167.3.05.C](#) in accordance with the provisions of this specification.

C. Failure to Comply with Specifications

If the Contractor fails to comply with any of the requirements of this Specification, all activities shall cease immediately except traffic control and erosion control related work.

Monies that are currently due or that may become due shall be withheld according to the specifications. In addition, nonrefundable monies shall be deducted from the contract as shown in the Schedule of Deductions table below. These deductions are in addition to any actions taken in the above subsections. Deductions assessed for uncorrected deficiencies shall continue until all corrections are completed to the satisfaction of the Engineer.

D. Receipt of a Consent Order or Notice of Violation, etc

Regulatory enforcement actions will be resolved including at a

- minimum the following steps; The Department will perform
- an internal review of the alleged violations
- The Department will then meet with the Contractor to review and further determine responsibilities for the alleged violations
- The Department will then arrange to collectively meet with the regulatory agencies to negotiate resolutions and/or settlements.

The Department does not waive any rights of the Contractor to resolve such matters however, in the event that regulatory agency communication is addressed jointly to the Department and to the contractor, the

Department reserves the right to coordinate all communications, e.g., written correspondence, and to schedule jointly attended meetings with Regulatory agencies such that timely and accurate responses are known to the Department.

Such Orders or Notices may result in the assessment of Deductions from the table below for each day the condition remains non-compliant following an agreed remedy.

Monetary penalties for which the contractor is obligated for as a result of regulatory enforcement may be withheld from future monies due the contractor.

| Schedule of Deductions for Each Calendar Day of Erosion Control Deficiencies Initial Occurrence* Original Total Contract Amount | | |
|--|------------------|--------------|
| From More Than | To and Including | Daily Charge |
| 0 | \$100,000 | \$750 |
| \$100,000 | \$1,000,000 | \$1125 |
| \$1,000,000 | \$5,000,000 | \$2000 |
| \$5,000,000 | \$15,000,000 | \$3000 |
| \$15,000,000 | - | \$5000 |

*Continued non-compliance with the requirements of this specification may result in the doubling of the above tabulated Daily Charge.

Upon written request from the Contractor, the Engineer may allow, limited activities to concurrently proceed once significant portions of the corrective work have been completed. This authorization may be similarly rescinded if in the opinion of the Engineer corrective work is not being diligently pursued.

CONCRETE TO BE TOP BRUSHED
WITH BLACK DYE

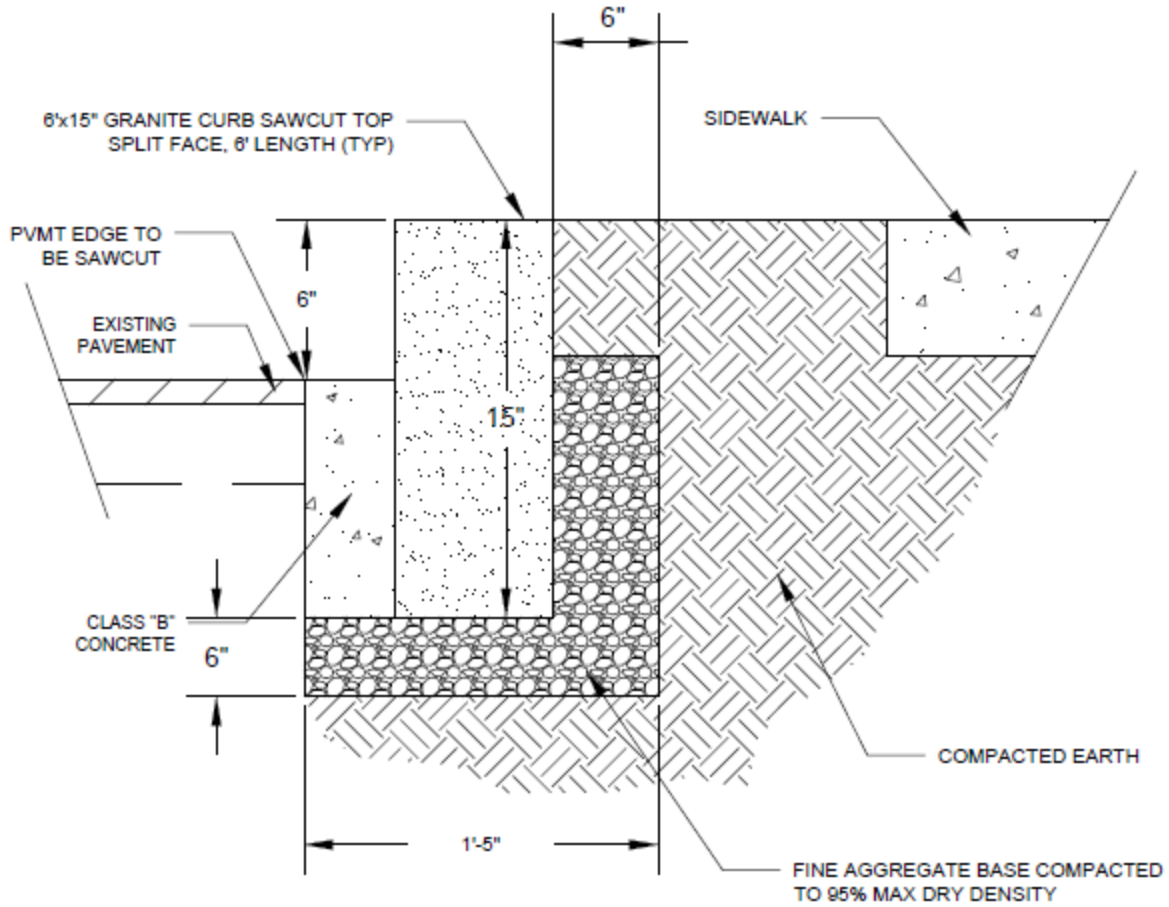

6" GRANITE CURB
DETAIL
SCALE: NTS



CITY OF BROOKHAVEN
PUBLIC WORKS DEPARTMENT
GRANITE CURB DETAIL

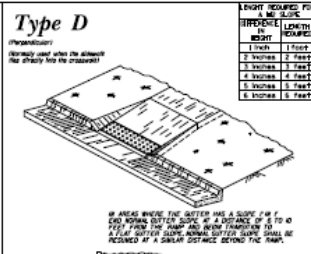
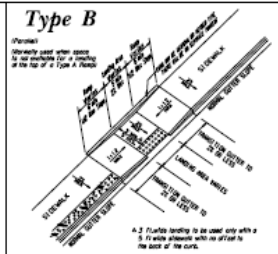
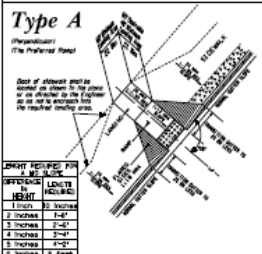
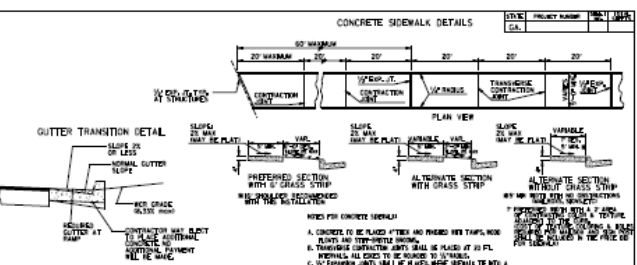
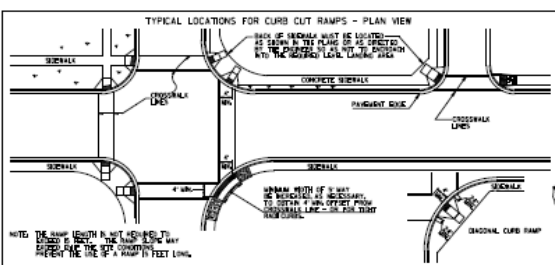

NOTES FOR CONCRETE SIDEWALK:

- CONCRETE SHALL BE PLACED AT THE CURB AND FINISHED WITH TYPICAL FINISH AND TYPICAL FINISHING.
- TRANSVERSE CONTRACT JOINTS SHALL BE PLACED AT 20' INTERVALS UNLESS OTHERWISE SPECIFIED.
- EXPANSION JOINTS SHALL BE PLACED MORE NEARLY TO THE CURB OR TO THE CENTER OF THE CURB OR TO THE CENTER OF THE SIDEWALK AS SHOWN.

NOTES FOR CURB CUT RAMPS:

- CURB CUT RAMPS SHALL BE LOCATED AS FOLLOWS UNLESS PLANS OR CONTRACT SPECIFY OTHERWISE:
 - AT ALL INTERSECTIONS UNLESS OTHERWISE SPECIFIED OR INDICATED BY THE CURB AT THE POINTS OF INTERSECTION.
 - AT OTHER LOCATIONS SUCH AS SIDEWALKS, SIDEWALK BAYS, FEET PATHS, ETC., UNLESS OTHERWISE SPECIFIED.
- RAMPS SHALL BE CONSTRUCTED FROM CONCRETE. SIDEWALKS OR RAMPS SHALL BE FINISHED TO THE CURB OR TO THE CENTER OF THE CURB OR TO THE CENTER OF THE SIDEWALK AS SHOWN.
- RAMPS SHALL BE FINISHED TO THE CURB OR TO THE CENTER OF THE CURB OR TO THE CENTER OF THE SIDEWALK AS SHOWN.
- RAMPS SHALL BE FINISHED TO THE CURB OR TO THE CENTER OF THE CURB OR TO THE CENTER OF THE SIDEWALK AS SHOWN.
- RAMPS SHALL BE FINISHED TO THE CURB OR TO THE CENTER OF THE CURB OR TO THE CENTER OF THE SIDEWALK AS SHOWN.
- RAMPS SHALL BE FINISHED TO THE CURB OR TO THE CENTER OF THE CURB OR TO THE CENTER OF THE SIDEWALK AS SHOWN.

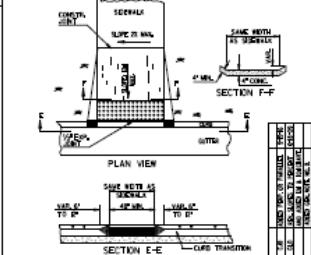
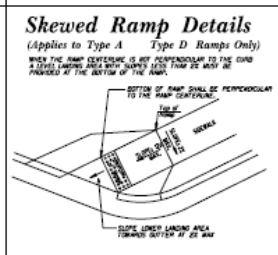
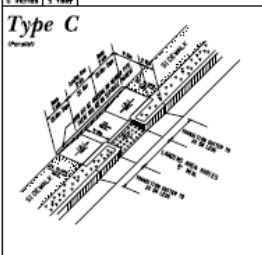

This Detail Replaces Georgia Standard 9031W
Substitute For Curb Cut Ramp

When these details are incorporated into plans and/or contracts that are being prepared or amended, it is the responsibility of the engineer to verify that the details are being used in accordance with the applicable code requirements. The engineer shall also verify that the details are being used in accordance with the applicable code requirements. The engineer shall also verify that the details are being used in accordance with the applicable code requirements.

DEPARTMENT OF TRANSPORTATION
STATE OF GEORGIA

SPECIAL DETAIL
CONCRETE SIDEWALK DETAILS
CURB CUT (WHEELCHAIR) RAMPS

NO SCALE

NUMBER
A3